

# ANBAUANLEITUNG

mounting instructions • instructions de montage • instrucciones de montaje • istruzioni di montaggio

## ADV.01.070.76004

beinhaltet • contains • contient • contiene • contiene

SBL.01.070.10002/B

MSS.01.070.10001/B

HDG.00.220.81402/B

HDG.00.220.10000/B

Item number: **SBL.01.070.10002/B**

Revision: **00** · Date: **04 - 2024**

## Crash bar

 ~ 1.5 h.

EASY  DIFFICULT

**ENGLISH** Thank you for choosing this premium product from SW-MOTECH. Visit our online shop for more information (e.g. model assignments). Required documents (e.g. national type approval) are available there for you to download.

Please read and understand all the instructions, safety information and warnings in these mounting instructions before mounting and using the product in order to avoid injury and damage. Keep these mounting instructions for reference.

This product was developed for vehicles in factory condition. Compatibility with original accessories or accessories from other manufacturers cannot be guaranteed.

These mounting instructions have been prepared to the best of our current knowledge. No legal claims relating to accuracy can be made. Errors and omissions excepted. We reserve the right to make technical and design changes. The copyright is held by SW-MOTECH.

### SAFETY WARNING SYMBOL

 This warning symbol is used in these mounting instructions to warn of deadly dangers, injuries or other hazards. The words **DANGER**, **WARNING** or **CAUTION** are used as part of this warning symbol to convey important safety messages and information relating to the installation and use of this product. These words, together with the safety warning symbol, mean:

 **DANGER:** Indicates a hazardous situation which, if not avoided, will result in death or serious injury!

 **WARNING:** Indicates a hazardous situation which, if not avoided, may result in death or serious injury!

 **CAUTION:** Indicates a hazardous situation which, if not avoided, may result in minor or moderate injury!

 **NOTE:** Important information, but not relating to a risk of death or injury (property damage only)!

### GENERAL INFORMATION

 **WARNING:** Assembly and/or maintenance of this product requires advanced technical skill, appropriate tools, and a good understanding of tool usage and torque specifications. For your own safety, SW-MOTECH recommends having the assembly and/or maintenance carried out by a qualified and certified motorcycle workshop.

 **WARNING:** If you do choose to assemble this product yourself, carefully and fully read the mounting instructions before assembly and use, and follow all instructions to avoid serious injury or death. Also observe all relevant information in the vehicle manual when mounting or using the product. IF YOU DO NOT UNDERSTAND ANY PART OF THESE MOUNTING INSTRUCTIONS OR NEED AN EXPLANATION AS TO A SPECIFIC INSTRUCTION, DO NOT ATTEMPT TO INSTALL THIS PRODUCT WITHOUT CONSULTING SW-MOTECH FOR ASSISTANCE!

**PREPARATION:** Read the mounting instructions carefully and make sure that all parts on the parts list are available.

 **CAUTION:** Ensure that your vehicle is standing securely. Switch off the engine and remove the ignition key. Allow the engine/exhaust to cool down if necessary. Disconnect the battery when working on the electrical system. Only use proper tools and always wear safety goggles and gloves during assembly and maintenance. Have a second person help you with assembly and maintenance.

**ASSEMBLY:** All parts and connections removed from the vehicle must be reinstalled according to the vehicle manufacturer's specifications or replaced with parts and hardware supplied by SW-MOTECH.

 **WARNING:** Secure all threads with a medium-strength liquid threadlocker, unless otherwise specified.

 **DANGER:** Tightening torques not defined by SW-MOTECH must be obtained from the vehicle manufacturer or a certified motorbike workshop.

**FUNCTIONAL CHECK:** After mounting the product, ensure that no moving parts are obstructed and that the function of the vehicle is not impeded. Cables and hoses must not rub against each other and/or be hindered in any way.

 **WARNING:** Carry out a comprehensive functionality check before you start to drive. Check the tightening torque of all connections and the tight fit of the product after the first 50 km and then at regular intervals. Mounted accessories can change the handling and stability of the vehicle.



SW-MOTECH GmbH & Co. KG  
Ernteweg 7-10  
35282 Rauschenberg  
Germany



 [info@sw-motech.com](mailto:info@sw-motech.com)  
 [www.sw-motech.com](http://www.sw-motech.com)



Take note of the symbols and what they mean in the ASSEMBLY section. If the term OEM appears in the ASSEMBLY section, the vehicle manufacturer's specifications must be observed and applied.



If you have any questions, please don't hesitate to contact our Customer Service team or our distributors. You can find our telephone number and a list of our distributors in our online shop:

[www.sw-motech.com](http://www.sw-motech.com)



**Use thread locker:** Indicates that a thread must be coated with liquid thread locker. H (HIGH): high strength; M (MEDIUM): medium strength; L (LOW): low strength.



































**Tighten/note the tightening torque information:**

Indicates the tightening torque of a part specified by SW-MOTECH or the vehicle manufacturer (OEM).



**Do not use thread lock:** Indicates that no liquid thread lock should be used at this point.

PARTS LIST - READ AND KEEP MOUNTING INSTRUCTIONS!

4	<p>1</p>  <p>SBL.01.070.901.02.11</p> <p> 1/1</p>	<p>2</p>  <p>SBL.01.070.902.02.11</p> <p> 1/1</p>	<p>3</p>  <p>M10 x 80; DIN 931 SC.ST.10.080.01.931.088</p> <p> 2/2</p>	<p>4</p>  <p>M10 x 80; DIN 912 SC.ST.10.080.01.912.088</p> <p> 2/2</p>	<p>5</p>  <p>M12 x 100; DIN 912 SC.ST.12.100.01.912F.088</p> <p> 2/2</p>	<p>6</p>  <p>∅ 10,5; DIN 125 US.ST.105.01.125</p> <p> 4/4</p>
	<p>7</p>  <p>∅ 13; DIN 125 US.ST.130.01.125</p> <p> 2/2</p>	<p>8</p>  <p>∅ 20 / ∅ 12,5 / h 51 DB.ST.0200.0125.0510.02</p> <p> 2/2</p>	<p>9</p>  <p>M10; DIN 6927 MU.ST.10.01.6927.08</p> <p> 4/4</p>			
5	<p>10</p>  <p>SBL.01.070.003.11</p> <p> 2/2</p>	<p>11</p>  <p>M8 x 50; DIN 912 SC.ST.08.050.02.912.088</p> <p> 4/4</p>	<p>12</p>  <p>∅ 8,4; DIN 125 US.ST.084.02.125</p> <p> 4/4</p>	<p>13</p>  <p>∅ 22 / ∅ 8,4 / h 6 DB.ST.0220.0084.0060.02</p> <p> 4/4</p>	<p>14</p>  <p>M8; DIN 6927 MU.ST.08.02.6927.08</p> <p> 4/4</p>	<p>15</p>  <p>M6 x 16; DIN 912 SC.ST.06.016.02.912.088</p> <p> 2/2</p>
	<p>16</p>  <p>M6; DIN 985 MU.ST.06.01.985.08</p> <p> 2/2</p>					

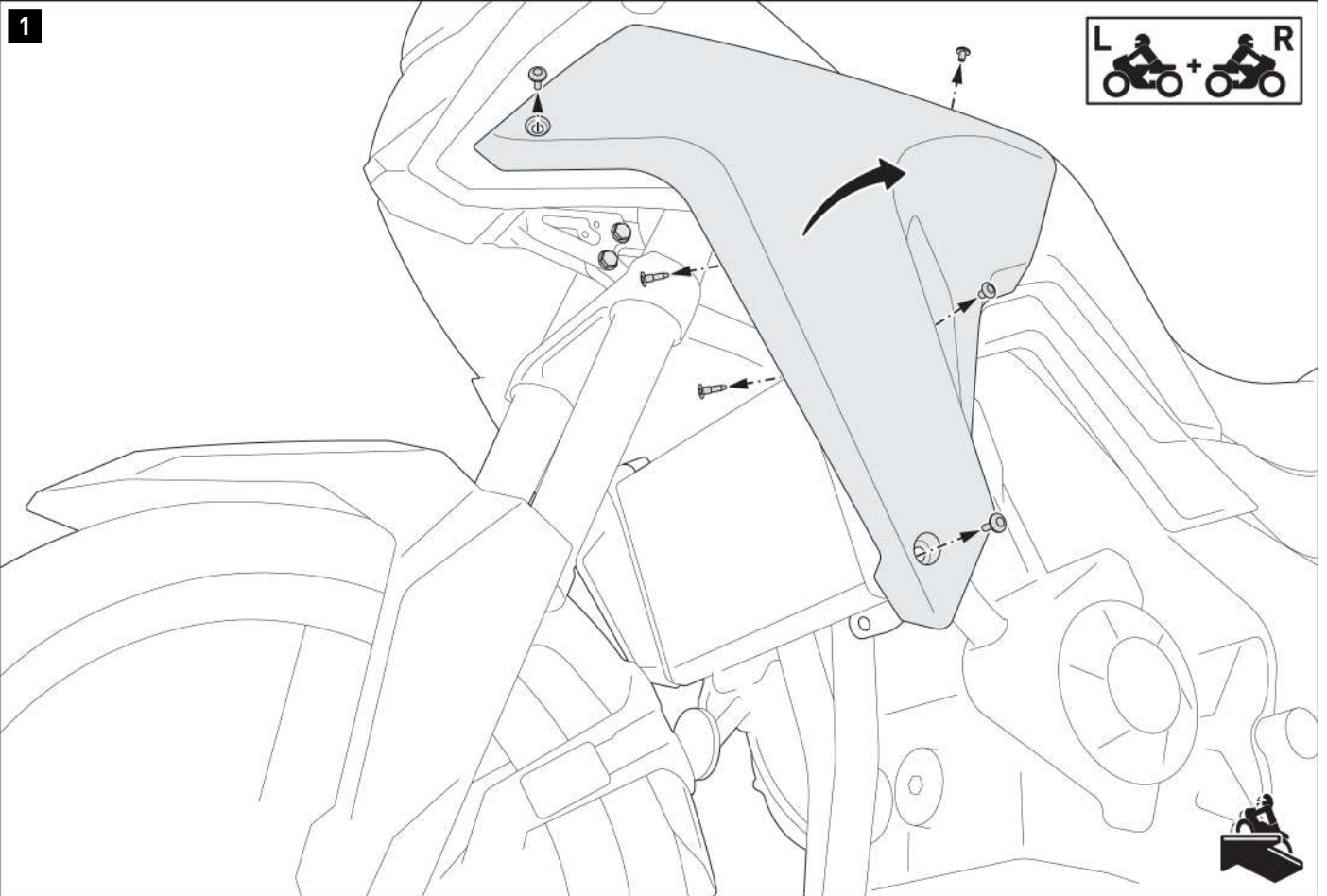

- ▲ **WARNING:** Always wear eye and hand protection!
- ▲ **WARNING:** Always use the proper tools!

▲ **WARNING:** Ensure the engine is properly supported using a corresponding jack!

Remove the original side panels from both sides of the vehicle.

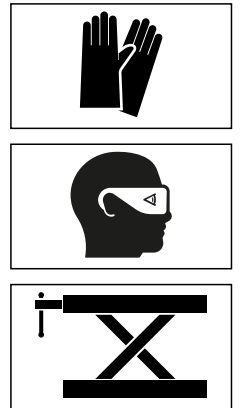

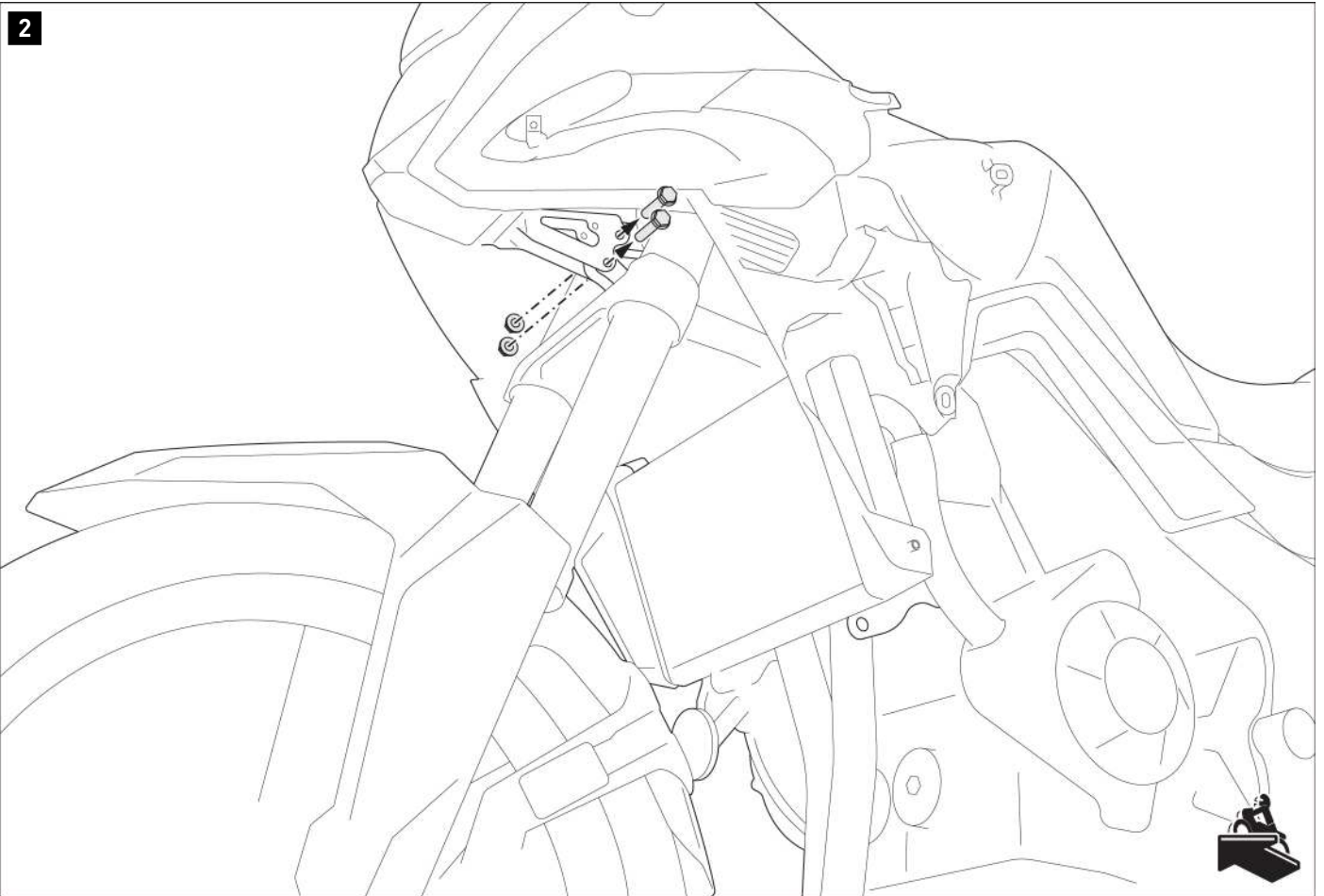

Remove the indicated screws.

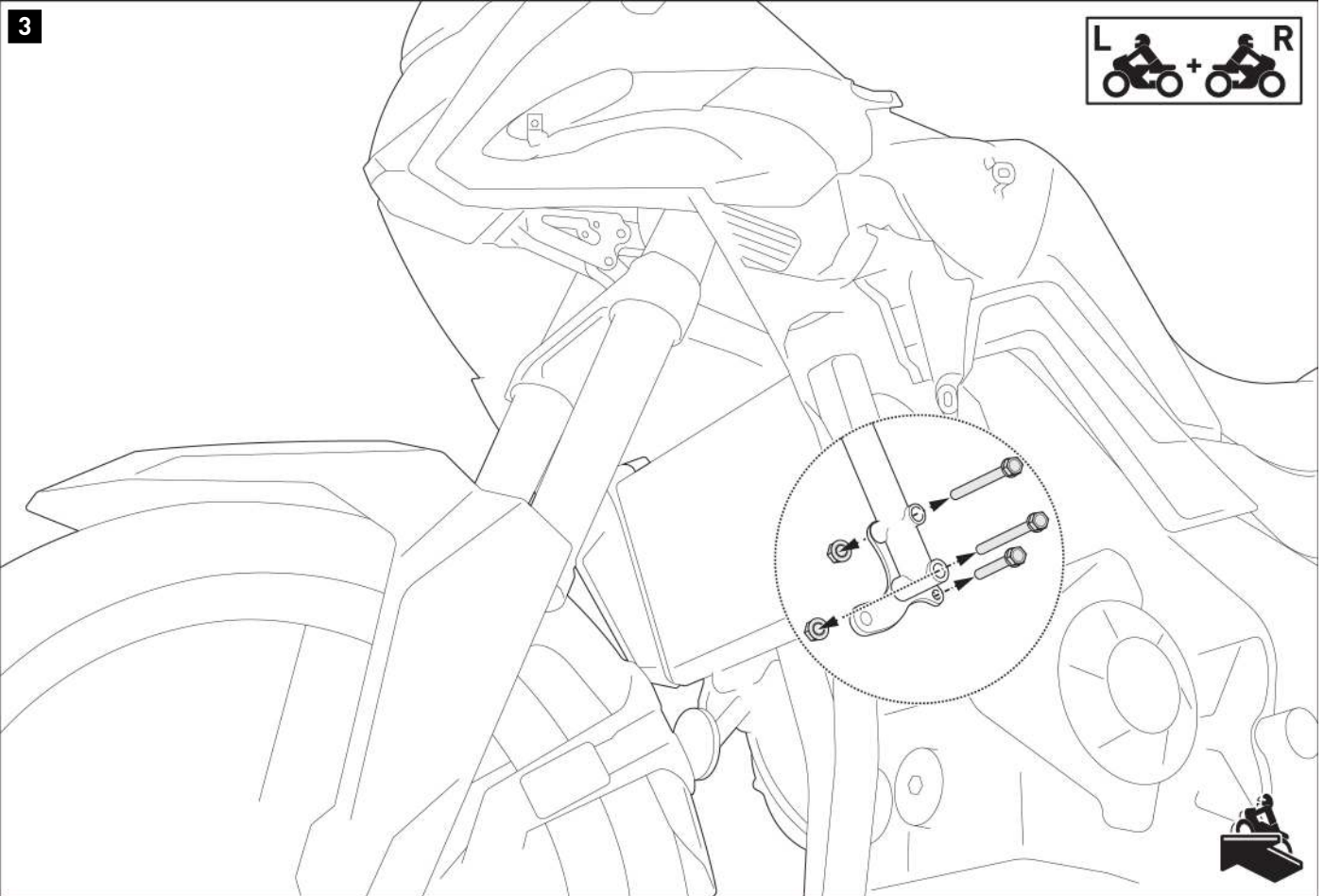

**▲WARNING: Fully complete steps [3] and [4] on the left side of the vehicle before starting on the right side!**

Remove the indicated screws.

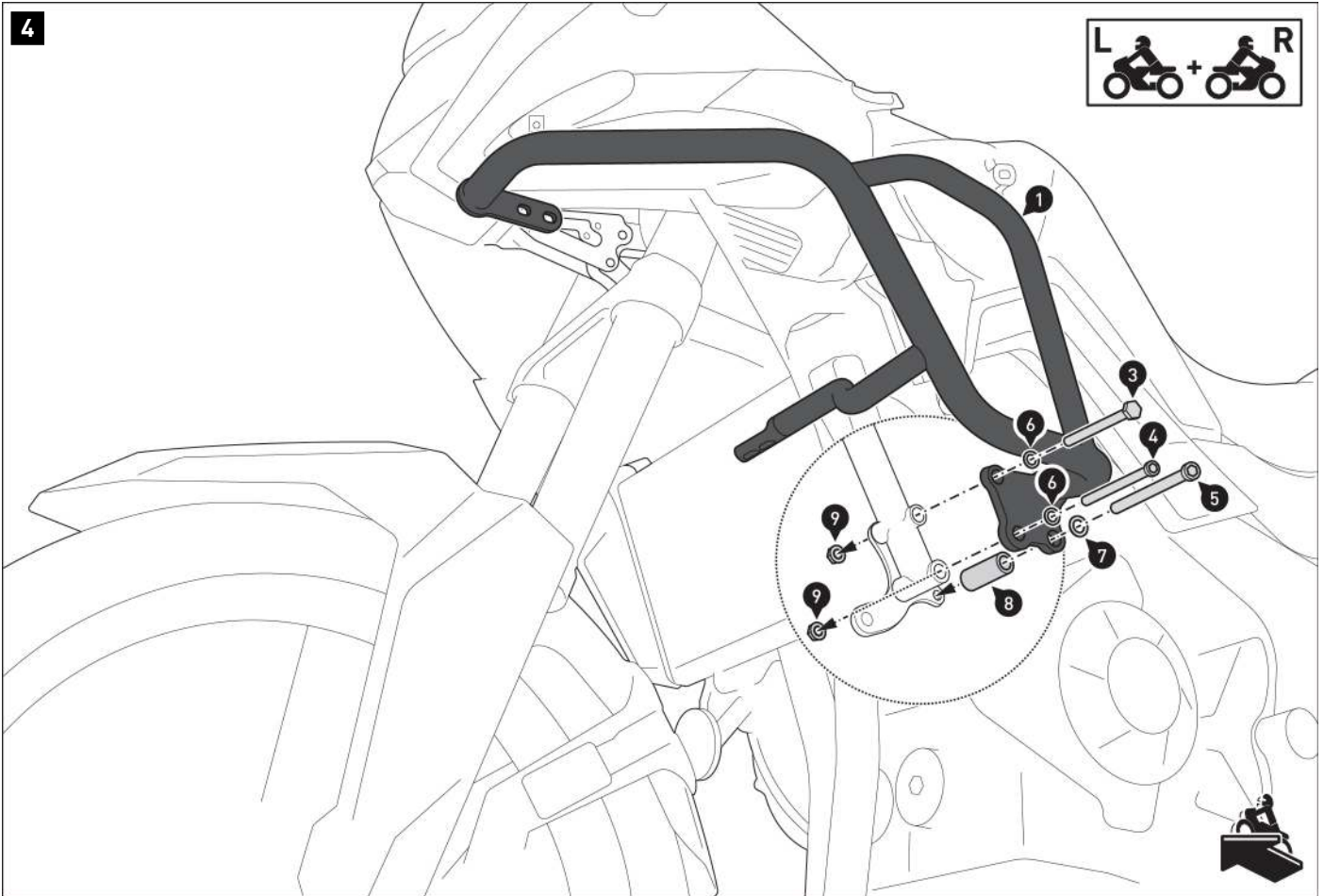

⚠ **NOTE:** Cover the fender to protect it from possible scratches!

Screw crash bar halves (1) and (2) onto the lower screw points on the vehicle.

⚠ **WARNING:** Use liquid thread locker (only screw (5))!  
Do not tighten screws (3), (4) and (5) yet.

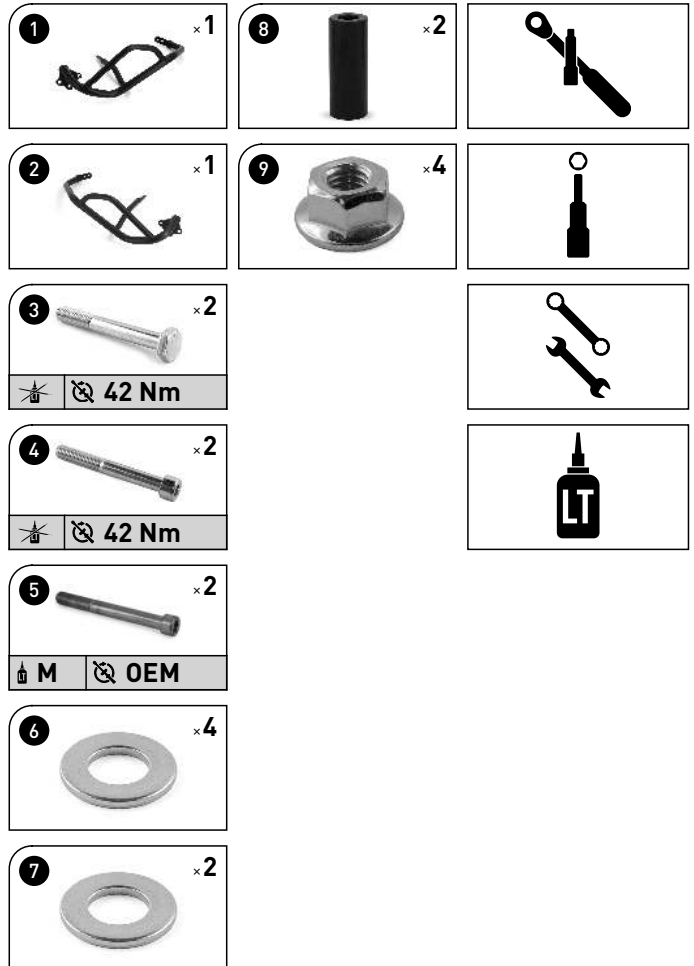



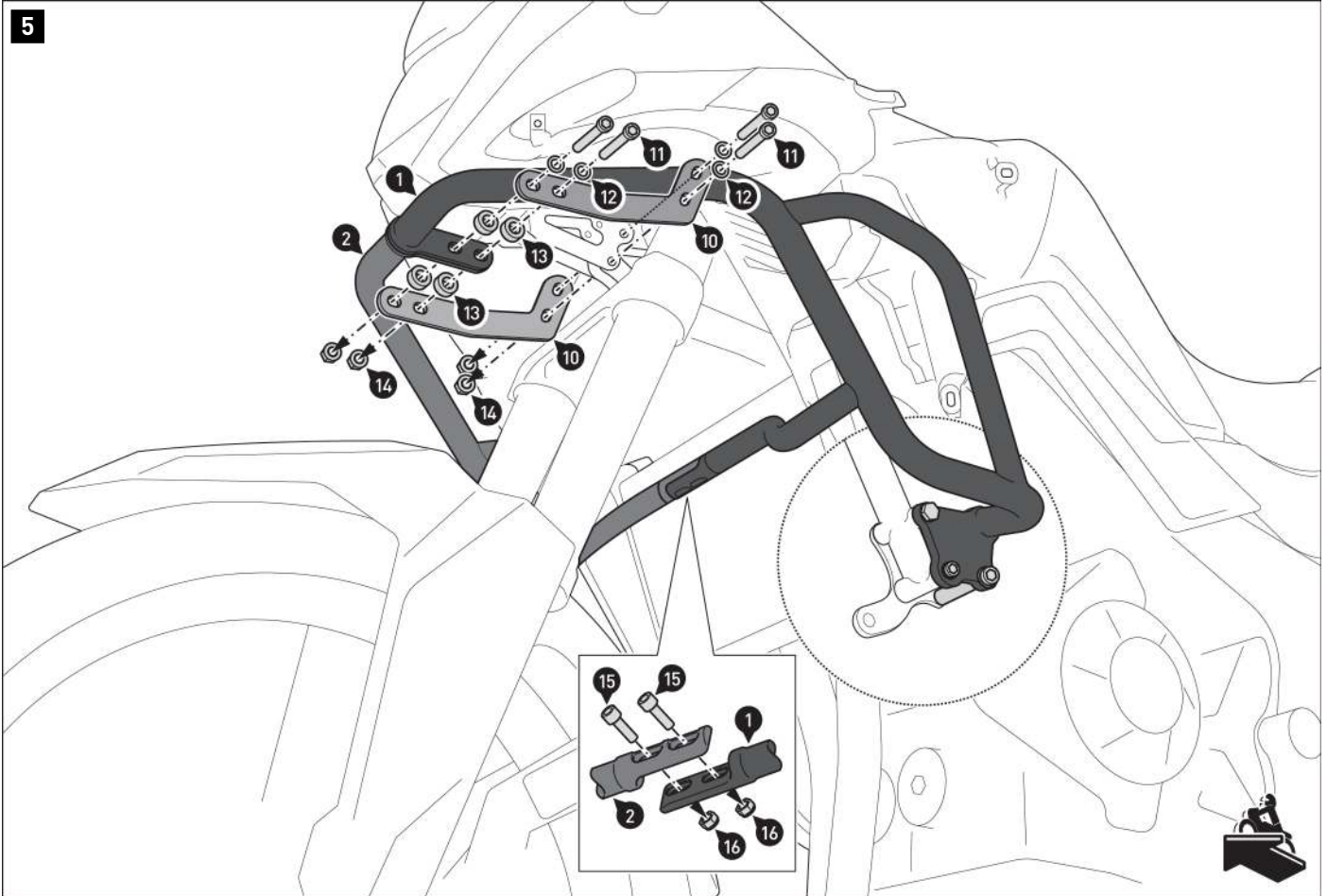

Screw the mounting brackets (10) onto the vehicle.  
Do not tighten the screws (11) yet.

Screw the mounting brackets (10) onto the crash bar halves (1) and (2).  
Do not tighten the screws (11) yet.

Now screw the two crash bar halves (1) and (2) together at the front.  
Do not tighten the screws (15) yet.

When all components have been loosely attached, tighten screws (3), (4), (11) and (15) as specified in the mounting instructions.  
Tighten the screws (5) according to the manufacturer's instructions.

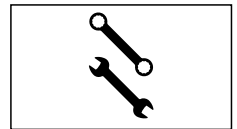
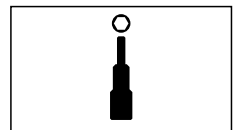
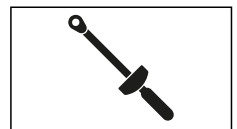

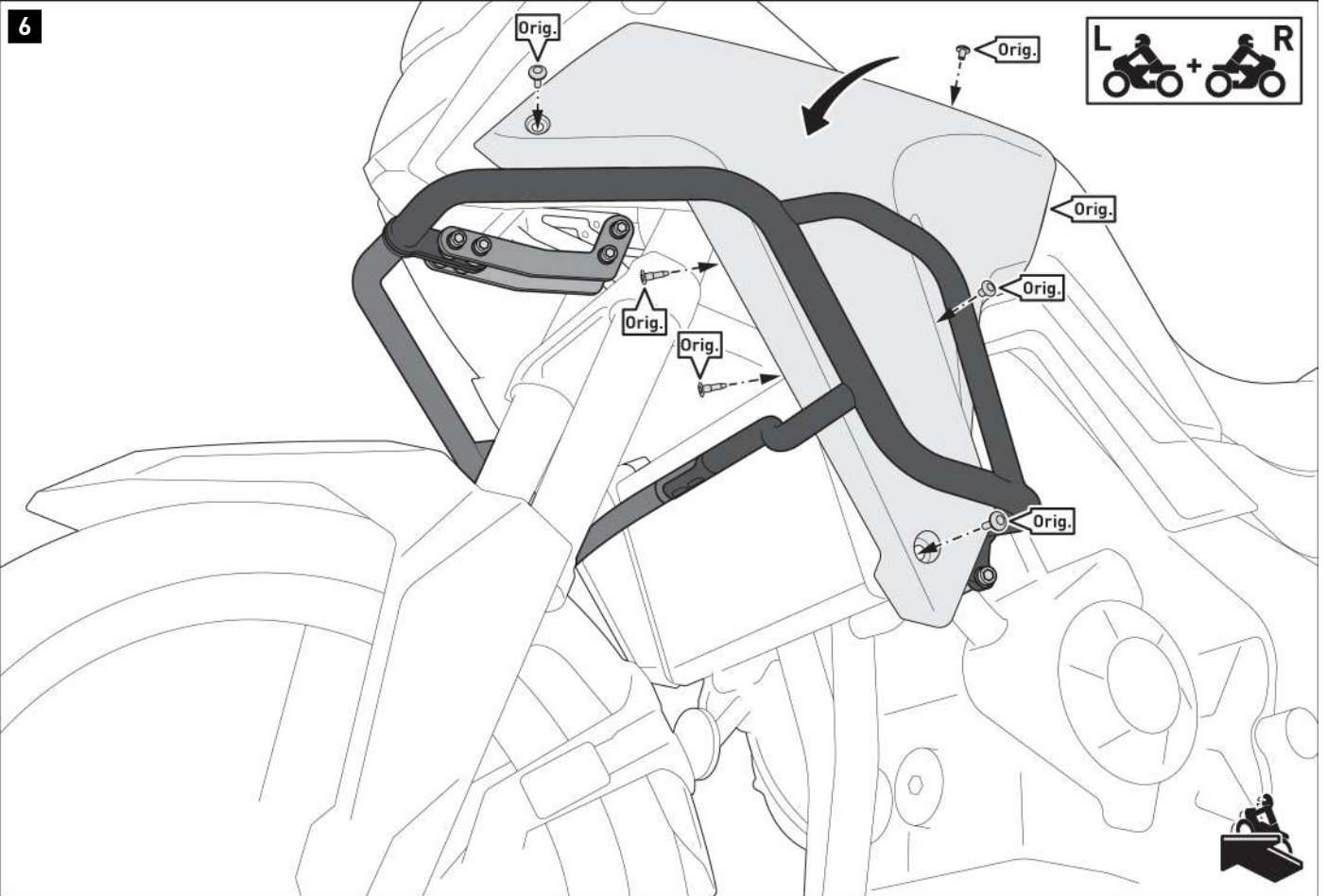

Finally, reattach the side panel.

PRODUCT-SPECIFIC NOTES

**⚠ WARNING: This product may inhibit cornering and ground clearance in cases of extreme inclination!**

**⚠ NOTE:** Please observe the country-specific regulations for the registration/operation of your vehicle or any applicable TÜV regulations. After installation, parts subject to registration should be entered in the vehicle documents by your test center.

Item number: **MSS.01.070.10001/B**

Revision: **00** · Date: **07 - 2023**

## Engine guard

 ~ 0.5 h.

EASY     DIFFICULT

**ENGLISH** Thank you for choosing this premium product from SW-MOTECH. Visit our online shop for more information (e.g. model assignments). Required documents (e.g. national type approval) are available there for you to download.

Please read and understand all the instructions, safety information and warnings in these mounting instructions before mounting and using the product in order to avoid injury and damage. Keep these mounting instructions for reference.

This product was developed for vehicles in factory condition. Compatibility with original accessories or accessories from other manufacturers cannot be guaranteed.

These mounting instructions have been prepared to the best of our current knowledge. No legal claims relating to accuracy can be made. Errors and omissions excepted. We reserve the right to make technical and design changes. The copyright is held by SW-MOTECH.

### SAFETY WARNING SYMBOL

 This warning symbol is used in these mounting instructions to warn of deadly dangers, injuries or other hazards. The words **DANGER**, **WARNING** or **CAUTION** are used as part of this warning symbol to convey important safety messages and information relating to the installation and use of this product. These words, together with the safety warning symbol, mean:

 **DANGER:** Indicates a hazardous situation which, if not avoided, will result in death or serious injury!

 **WARNING:** Indicates a hazardous situation which, if not avoided, may result in death or serious injury!

 **CAUTION:** Indicates a hazardous situation which, if not avoided, may result in minor or moderate injury!

 **NOTE:** Important information, but not relating to a risk of death or injury (property damage only)!

### GENERAL INFORMATION

 **WARNING:** Assembly and/or maintenance of this product requires advanced technical skill, appropriate tools, and a good understanding of tool usage and torque specifications. For your own safety, SW-MOTECH recommends having the assembly and/or maintenance carried out by a qualified and certified motorcycle workshop.

 **WARNING:** If you do choose to assemble this product yourself, carefully and fully read the mounting instructions before assembly and use, and follow all instructions to avoid serious injury or death. Also observe all relevant information in the vehicle manual when mounting or using the product. IF YOU DO NOT UNDERSTAND ANY PART OF THESE MOUNTING INSTRUCTIONS OR NEED AN EXPLANATION AS TO A SPECIFIC INSTRUCTION, DO NOT ATTEMPT TO INSTALL THIS PRODUCT WITHOUT CONSULTING SW-MOTECH FOR ASSISTANCE!

**PREPARATION:** Read the mounting instructions carefully and make sure that all parts on the parts list are available.

 **CAUTION:** Ensure that your vehicle is standing securely. Switch off the engine and remove the ignition key. Allow the engine/exhaust to cool down if necessary. Disconnect the battery when working on the electrical system. Only use proper tools and always wear safety goggles and gloves during assembly and maintenance. Have a second person help you with assembly and maintenance.

**ASSEMBLY:** All parts and connections removed from the vehicle must be reinstalled according to the vehicle manufacturer's specifications or replaced with parts and hardware supplied by SW-MOTECH.

 **WARNING:** Secure all threads with a medium-strength liquid threadlocker, unless otherwise specified.

 **DANGER:** Tightening torques not defined by SW-MOTECH must be obtained from the vehicle manufacturer or a certified motorbike workshop.

**FUNCTIONAL CHECK:** After mounting the product, ensure that no moving parts are obstructed and that the function of the vehicle is not impeded. Cables and hoses must not rub against each other and/or be hindered in any way.

 **WARNING:** Carry out a comprehensive functionality check before you start to drive. Check the tightening torque of all connections and the tight fit of the product after the first 50 km and then at regular intervals. Mounted accessories can change the handling and stability of the vehicle.



SW-MOTECH GmbH & Co. KG  
Ernteweg 7-10  
35282 Rauschenberg  
Germany



 [info@sw-motech.com](mailto:info@sw-motech.com)  
 [www.sw-motech.com](http://www.sw-motech.com)



Take note of the symbols and what they mean in the ASSEMBLY section. If the term OEM appears in the ASSEMBLY section, the vehicle manufacturer's specifications must be observed and applied.



If you have any questions, please don't hesitate to contact our Customer Service team or our distributors. You can find our telephone number and a list of our distributors in our online shop:

**[www.sw-motech.com](http://www.sw-motech.com)**



**Do not use thread lock:** Indicates that no liquid thread lock should be used at this point.



























**Tighten/note the tightening torque information:**

Indicates the tightening torque of a part specified by SW-MOTECH or the vehicle manufacturer (OEM).



**Use thread locker:** Indicates that a thread must be coated with liquid thread locker. H (HIGH): high strength; M (MEDIUM): medium strength; L (LOW): low strength.

**PARTS LIST - READ AND KEEP MOUNTING INSTRUCTIONS!**

<p><b>1</b></p> <p><b>1</b></p>  <p>MSS.01.070.002.11</p> <p> 1/1</p>	<p><b>2</b></p>  <p>MSS.01.070.003.11</p> <p> 1/1</p>	<p><b>3</b></p>  <p>M8 x 30; DIN 931 SC.ST.08.030.01.931.088</p> <p> 2/2</p>	<p><b>4</b></p>  <p>M8 x 25; DIN 933 SC.ST.08.025.01.933.088</p> <p> 2/2</p>	<p><b>5</b></p>  <p>ø 8,4; DIN 125 US.ST.084.01.125</p> <p> 4/8</p>	<p><b>6</b></p>  <p>Ø 20 / ø 8,5 / h 10 DB.00.200.085.010.01</p> <p> 2/2</p>
<p><b>7</b></p>  <p>M8; DIN 6927 MU.ST.08.01.6927.08</p> <p> 4/4</p>					
<p><b>2</b></p> <p><b>8</b></p>  <p>MSS.01.070.900.01.02</p> <p> 1/1</p>	<p><b>9</b></p>  <p>M8 x 16; DIN 933 SC.ST.08.016.01.933.109</p> <p> 4/4</p>	<p><b>10</b></p>  <p>ø 8,4; DIN 125 US.ST.084.01.125</p> <p> 4/8</p>	<p><b>11</b></p>  <p>M8 x 25; DIN 7991 SC.ST.08.025.02.7991.088</p> <p> 2/2</p>	<p><b>12</b></p>  <p>ø 8.4 SE.00.084.02</p> <p> 2/2</p>	

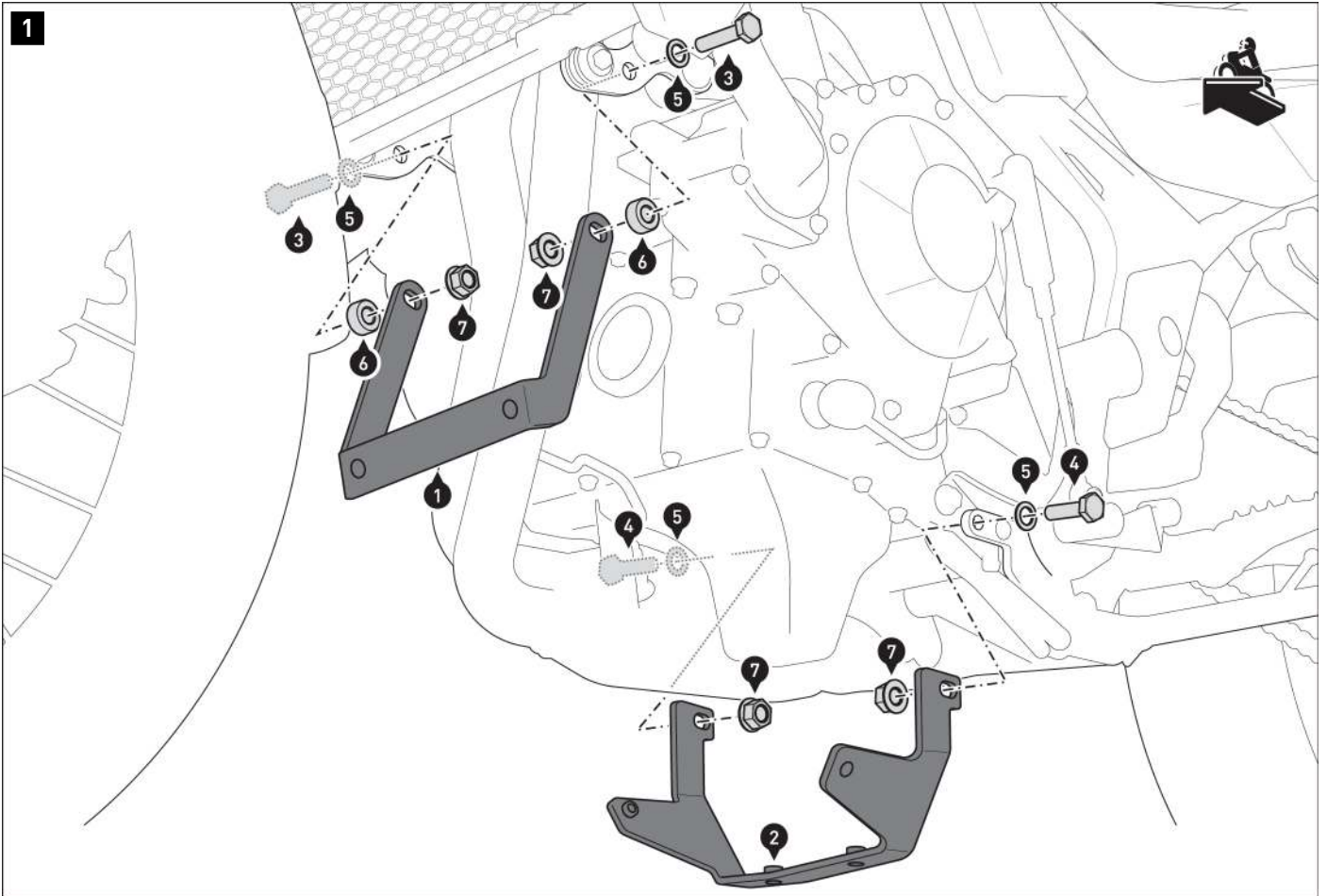

**▲ WARNING: Always wear eye and hand protection!**  
**▲ WARNING: Always use the proper tools!**

Screw mounting brackets (1) and (2) to the vehicle on both sides.  
 Do not tighten the screw yet.

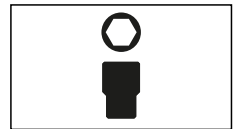
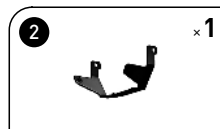

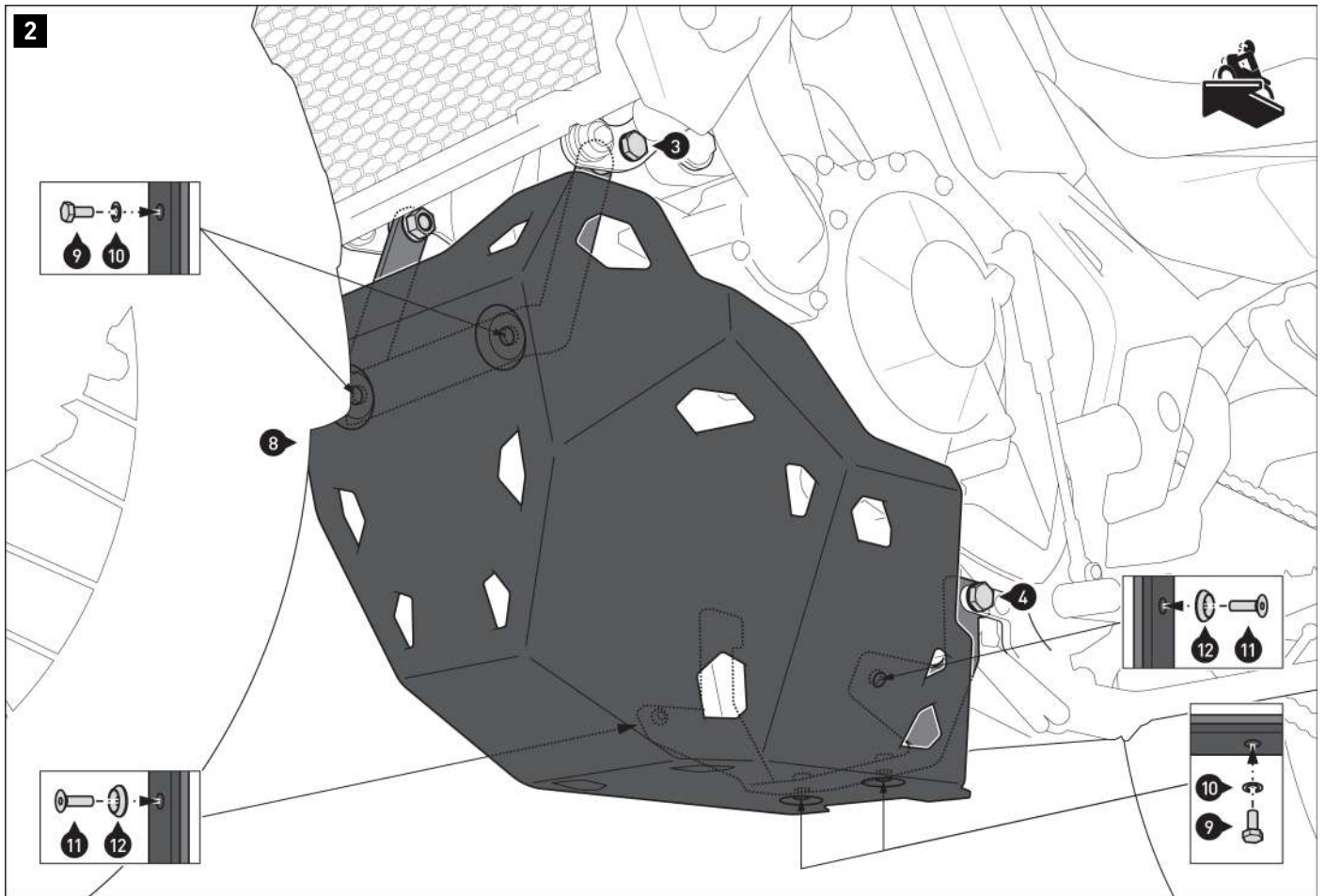

Screw the engine guard (8) to mounting brackets (1) and (2).

**▲ WARNING: Use a liquid threadlocker!**

When all components have been loosely attached, tighten the screws as specified and in the following order: screws (11), screws (9) underneath, screws (9) in front, screws (4) and screws (3).

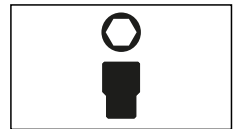
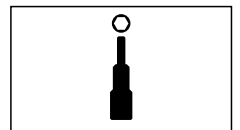
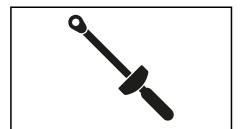
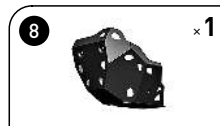



PRODUCT-SPECIFIC NOTES

**⚠ WARNING: Ground clearance may be restricted by this product! Particular caution is required when cornering at extreme inclination and/or driving on uneven ground (e.g. curbs and bumps)!**

**⚠ WARNING: Motorcycle exhaust pipes often have large geometric tolerances. Make sure that there is sufficient distance between all parts in the affected areas!**

**⚠ NOTE:** *Please observe the country-specific regulations for the registration/operation of your vehicle or any applicable TÜV regulations. After installation, parts subject to registration should be entered in the vehicle documents by your test center.*

Item number: HDG.00.220.81402/B

Revision: 00 · Date: 04 - 2024

## Handguard mounting kit

 ~ 0.5 h.

EASY     DIFFICULT

**ENGLISH** Thank you for choosing this premium product from SW-MOTECH. Visit our online shop for more information (e.g. model assignments). Required documents (e.g. national type approval) are available there for you to download.

Please read and understand all the instructions, safety information and warnings in these mounting instructions before mounting and using the product in order to avoid injury and damage. Keep these mounting instructions for reference.

This product was developed for vehicles in factory condition. Compatibility with original accessories or accessories from other manufacturers cannot be guaranteed.

These mounting instructions have been prepared to the best of our current knowledge. No legal claims relating to accuracy can be made. Errors and omissions excepted. We reserve the right to make technical and design changes. The copyright is held by SW-MOTECH.

### SAFETY WARNING SYMBOL

 This warning symbol is used in these mounting instructions to warn of deadly dangers, injuries or other hazards. The words DANGER, WARNING or CAUTION are used as part of this warning symbol to convey important safety messages and information relating to the installation and use of this product. These words, together with the safety warning symbol, mean:

 **DANGER:** Indicates a hazardous situation which, if not avoided, will result in death or serious injury!

 **WARNING:** Indicates a hazardous situation which, if not avoided, may result in death or serious injury!

 **CAUTION:** Indicates a hazardous situation which, if not avoided, may result in minor or moderate injury!

 **NOTE:** Important information, but not relating to a risk of death or injury (property damage only)!

### GENERAL INFORMATION

 **WARNING:** Assembly and/or maintenance of this product requires advanced technical skill, appropriate tools, and a good understanding of tool usage and torque specifications. For your own safety, SW-MOTECH recommends having the assembly and/or maintenance carried out by a qualified and certified motorcycle workshop.

 **WARNING:** If you do choose to assemble this product yourself, carefully and fully read the mounting instructions before assembly and use, and follow all instructions to avoid serious injury or death. Also observe all relevant information in the vehicle manual when mounting or using the product. IF YOU DO NOT UNDERSTAND ANY PART OF THESE MOUNTING INSTRUCTIONS OR NEED AN EXPLANATION AS TO A SPECIFIC INSTRUCTION, DO NOT ATTEMPT TO INSTALL THIS PRODUCT WITHOUT CONSULTING SW-MOTECH FOR ASSISTANCE!

**PREPARATION:** Read the mounting instructions carefully and make sure that all parts on the parts list are available.

 **CAUTION:** Ensure that your vehicle is standing securely. Switch off the engine and remove the ignition key. Allow the engine/exhaust to cool down if necessary. Disconnect the battery when working on the electrical system. Only use proper tools and always wear safety goggles and gloves during assembly and maintenance. Have a second person help you with assembly and maintenance.

**ASSEMBLY:** All parts and connections removed from the vehicle must be reinstalled according to the vehicle manufacturer's specifications or replaced with parts and hardware supplied by SW-MOTECH.

 **WARNING:** Secure all threads with a medium-strength liquid threadlocker, unless otherwise specified.

 **DANGER:** Tightening torques not defined by SW-MOTECH must be obtained from the vehicle manufacturer or a certified motorbike workshop.

**FUNCTIONAL CHECK:** After mounting the product, ensure that no moving parts are obstructed and that the function of the vehicle is not impeded. Cables and hoses must not rub against each other and/or be hindered in any way.

 **WARNING:** Carry out a comprehensive functionality check before you start to drive. Check the tightening torque of all connections and the tight fit of the product after the first 50 km and then at regular intervals. Mounted accessories can change the handling and stability of the vehicle.



SW-MOTECH GmbH & Co. KG  
Ernteweg 7-10  
35282 Rauschenberg  
Germany



 [info@sw-motech.com](mailto:info@sw-motech.com)  
 [www.sw-motech.com](http://www.sw-motech.com)



Take note of the symbols and what they mean in the ASSEMBLY section. If the term OEM appears in the ASSEMBLY section, the vehicle manufacturer's specifications must be observed and applied.



If you have any questions, please don't hesitate to contact our Customer Service team or our distributors. You can find our telephone number and a list of our distributors in our online shop:

[www.sw-motech.com](http://www.sw-motech.com)



**Use thread locker:** Indicates that a thread must be coated with liquid thread locker. H (HIGH): high strength; M (MEDIUM): medium strength; L (LOW): low strength.



**Tighten/note the tightening torque information:** Indicates the tightening torque of a part specified by SW-MOTECH or the vehicle manufacturer (OEM).



**Do not use thread lock:** Indicates that no liquid thread lock should be used at this point.

**PARTS LIST - READ AND KEEP MOUNTING INSTRUCTIONS!**

**1**

**1**



HDG.00.220.904.01.02

 1/1

**2**



HDG.00.220.905.01.02

 1/1

**3**



HDG.01.070.001L.25

 1/1

**4**



HDG.01.070.001R.25

 1/1

**5**



M6 x 20; DIN 7380  
SC.ST.06.020.02.7380.109

 2/2

**2**

**6**



HDG.00.220.029L.25

 1/1

**7**



HDG.00.220.029R.25

 1/1

**8**



M6 x 35; DIN 912  
SC.ST.06.035.02.912.088

 2/2

**9**



HDG.00.220.012.25

 2/2

**10**



Ø 18 / ø 6.4 / h 15  
DB.ST.0180.0064.0150.02

 2/2

**3**

**11**



M6 x 22; DIN 7991  
SC.ST.06.022.48.7991.088

 2/2

**12**



ø 6.4; DIN 9021  
US.ST.064.02.9021

 2/2

**13**



M6; DIN 6927  
MU.ST.06.02.6927.08

 2/2

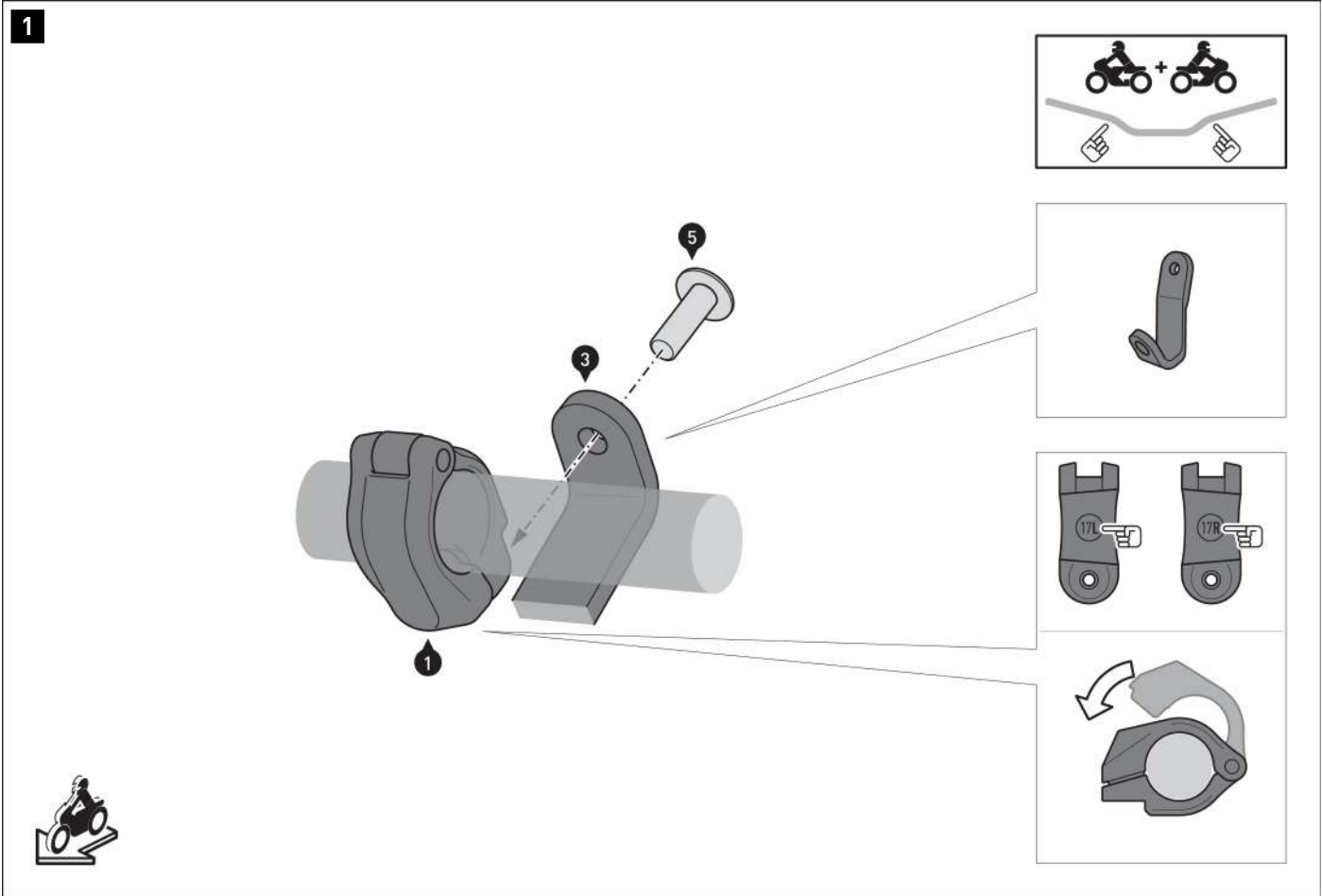

**⚠ WARNING:** Since the handguard mounting kit is installed in a safety-relevant area of the vehicle, SW-MOTECH recommends having the installation/maintenance of the product carried out by a qualified specialist workshop.

**⚠ WARNING:** Always wear eye and hand protection!  
**⚠ WARNING:** Always use the proper tools!

**⚠ NOTE:** Installation is shown on the left side. Repeat the installation with the corresponding parts on the right side of the handlebar.

**⚠ NOTE:** The handlebar shown serves as an example.

**⚠ NOTE:** The connecting plate (3) shown in the drawing serves as an example. The correct representation and orientation of the connecting plate are shown in the detailed drawing on the right.

**⚠ NOTE:** Pay attention to the L/R markings on the clamps (1/2). Attach the clamp with the L marking on the left side of the handlebar in the direction of travel; attach the clamp with the R engraving to the right side of the handlebar in the direction of travel.

Place the clamps (1/2) around the handlebars at the locations shown in the detailed drawing above.

LOOSELY screw the connecting plates (3/4) to the clamps (1/2). The clamps (1/2) must be able to be moved for positioning.

**⚠ WARNING:** Use a liquid threadlocker!  
 Tighten the screws (5) hand-tight.



M 8 Nm

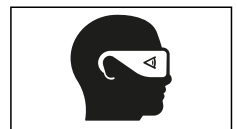

2

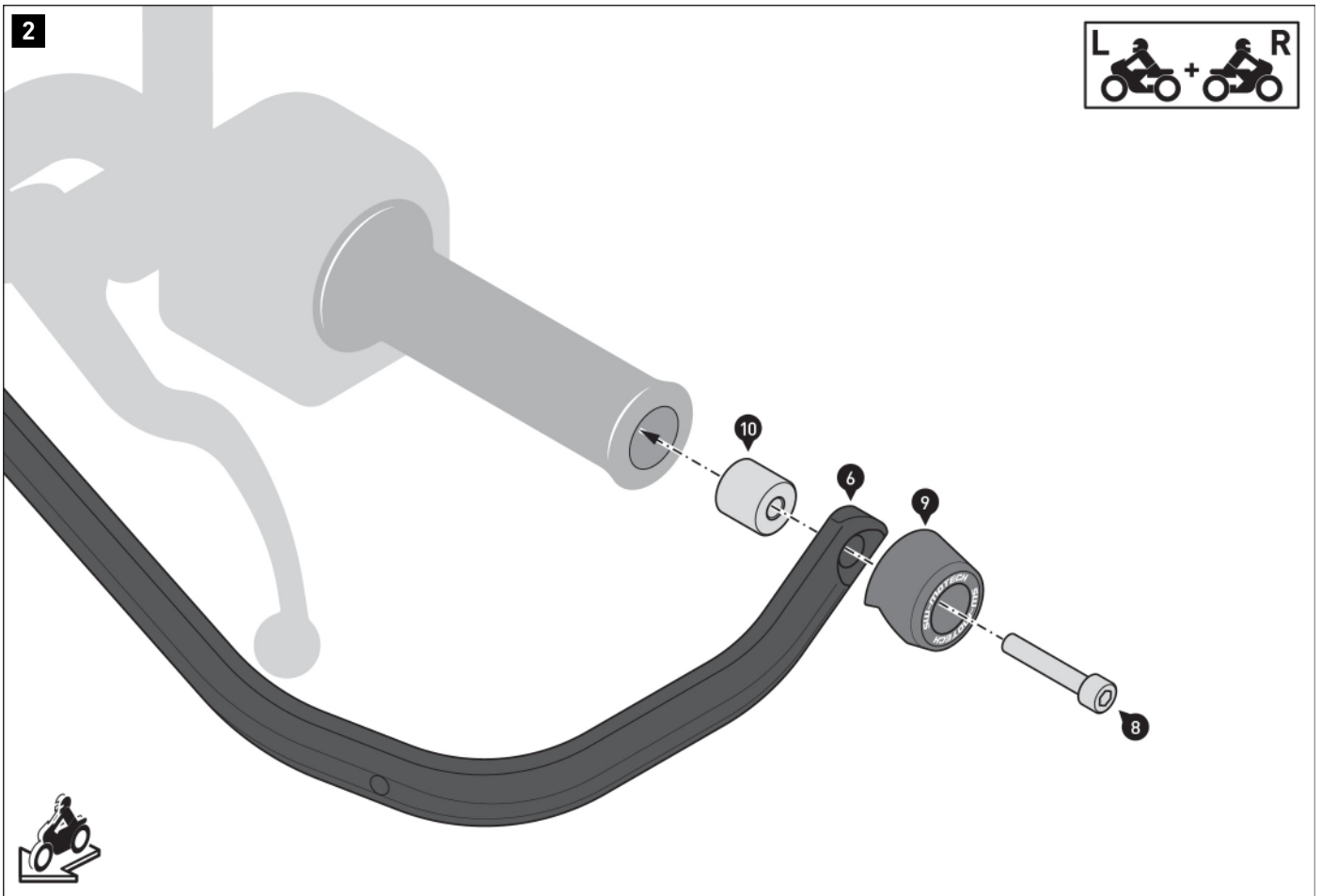

Remove the original end weights and handguards if mounted.  
Make sure the handlebar ends and the inside of the handlebars are clear.

Loosely screw the parts indicated to the brackets (6/7) on the handlebar ends.  
**▲ WARNING: Use a liquid threadlocker!**

To do so, tighten the screw (8) so that the brackets (6/7) can still be readjusted.

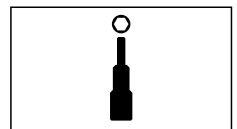

3

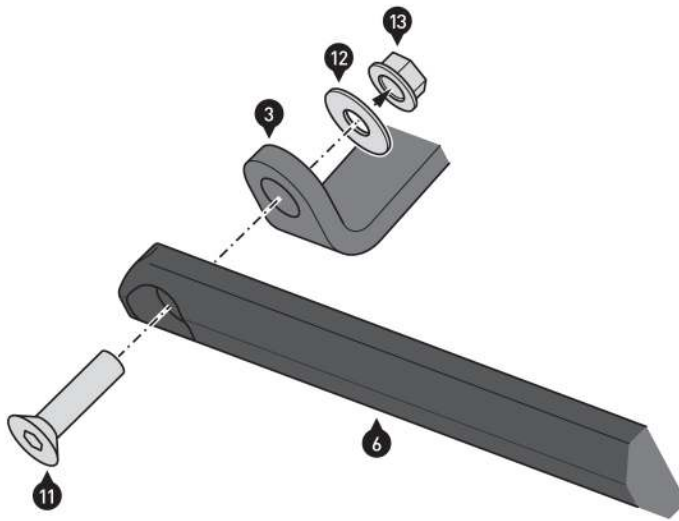

Screw the inner ends of the brackets (6/7) to the connecting plates (3/4). Do not tighten the screws (11) yet.

Now position the brackets (6/7) according to your personal preferences and tighten all screws in the following order and as specified in the mounting instructions: (11), (5), (8).

**⚠ DANGER:** If there is not enough space after installation of all components, the brake and clutch unit must be moved a few millimeters towards the end or middle of the handlebar!

**⚠ DANGER:** After installation, make sure that all switch and control units, especially the throttle assembly, brake lever, emergency stop switch and clutch, function properly and are easy to use! Also make sure that the handlebars can be fully turned in both directions. If parts of the product come into contact with the tank or other vehicle components when the steering wheel is at full lock, repositioning the product or the handlebars is absolutely necessary! Make sure that the installation complies with the vehicle manufacturer's specifications! DO NOT ride your vehicle if the switch and control units are not functioning correctly or cannot be operated correctly! BEFORE every ride, carry out a complete functional check of the handlebars and all fittings!

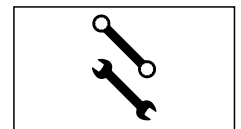
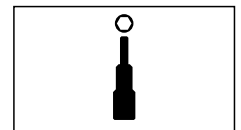
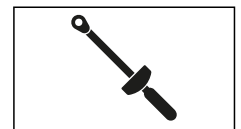

**PRODUCT-SPECIFIC NOTES**

**⚠ NOTE:** *Observe the country-specific regulations for the registration/operation of your vehicle or applicable TÜV regulations. After assembly, have parts that are subject to registration entered in the vehicle documents by your test centre.*



Item number: HDG.00.220.10000/B

Revision: 01 · Date: 12 - 2023

## Adventure handguard shell set

⌚ ~ 0.25 h.

EASY      DIFFICULT

**ENGLISH** Thank you for choosing this premium product from SW-MOTECH. Visit our online shop for more information (e.g. model assignments). Required documents (e.g. national type approval) are available there for you to download.

Please read and understand all the instructions, safety information and warnings in these mounting instructions before mounting and using the product in order to avoid injury and damage. Keep these mounting instructions for reference.

This product was developed for vehicles in factory condition. Compatibility with original accessories or accessories from other manufacturers cannot be guaranteed.

These mounting instructions have been prepared to the best of our current knowledge. No legal claims relating to accuracy can be made. Errors and omissions excepted. We reserve the right to make technical and design changes. The copyright is held by SW-MOTECH.

## SAFETY WARNING SYMBOL

⚠ This warning symbol is used in these mounting instructions to warn of deadly dangers, injuries or other hazards. The words **DANGER**, **WARNING** or **CAUTION** are used as part of this warning symbol to convey important safety messages and information relating to the installation and use of this product. These words, together with the safety warning symbol, mean:

⚠ **DANGER:** Indicates a hazardous situation which, if not avoided, will result in death or serious injury!

⚠ **WARNING:** Indicates a hazardous situation which, if not avoided, may result in death or serious injury!

⚠ **CAUTION:** Indicates a hazardous situation which, if not avoided, may result in minor or moderate injury!

⚠ **NOTE:** Important information, but not relating to a risk of death or injury (property damage only)!

## GENERAL INFORMATION

⚠ **WARNING:** Assembly and/or maintenance of this product requires advanced technical skill, appropriate tools, and a good understanding of tool usage and torque specifications. For your own safety, SW-MOTECH recommends having the assembly and/or maintenance carried out by a qualified and certified motorcycle workshop.

⚠ **WARNING:** If you do choose to assemble this product yourself, carefully and fully read the mounting instructions before assembly and use, and follow all instructions to avoid serious injury or death. Also observe all relevant information in the vehicle manual when mounting or using the product. IF YOU DO NOT UNDERSTAND ANY PART OF THESE MOUNTING INSTRUCTIONS OR NEED AN EXPLANATION AS TO A SPECIFIC INSTRUCTION, DO NOT ATTEMPT TO INSTALL THIS PRODUCT WITHOUT CONSULTING SW-MOTECH FOR ASSISTANCE!

**PREPARATION:** Read the mounting instructions carefully and make sure that all parts on the parts list are available.

⚠ **CAUTION:** Ensure that your vehicle is standing securely. Switch off the engine and remove the ignition key. Allow the engine/exhaust to cool down if necessary. Disconnect the battery when working on the electrical system. Only use proper tools and always wear safety goggles and gloves during assembly and maintenance. Have a second person help you with assembly and maintenance.

**ASSEMBLY:** All parts and connections removed from the vehicle must be reinstalled according to the vehicle manufacturer's specifications or replaced with parts and hardware supplied by SW-MOTECH.

⚠ **WARNING:** Secure all threads with a medium-strength liquid threadlocker, unless otherwise specified.

⚠ **DANGER:** Tightening torques not defined by SW-MOTECH must be obtained from the vehicle manufacturer or a certified motorbike workshop.

**FUNCTIONAL CHECK:** After mounting the product, ensure that no moving parts are obstructed and that the function of the vehicle is not impeded. Cables and hoses must not rub against each other and/or be hindered in any way.

⚠ **WARNING:** Carry out a comprehensive functionality check before you start to drive. Check the tightening torque of all connections and the tight fit of the product after the first 50 km and then at regular intervals. Mounted accessories can change the handling and stability of the vehicle.



SW-MOTECH GmbH & Co. KG  
Ernteweg 7-10  
35282 Rauschenberg  
Germany



✉ info@sw-motech.com  
🌐 www.sw-motech.com

**LEGEND OVERVIEW - READ AND KEEP MOUNTING INSTRUCTIONS!**



Take note of the symbols and what they mean in the ASSEMBLY section. If the term OEM appears in the ASSEMBLY section, the vehicle manufacturer's specifications must be observed and applied.



If you have any questions, please don't hesitate to contact our Customer Service team or our distributors. You can find our telephone number and a list of our distributors in our online shop:

**[www.sw-motech.com](http://www.sw-motech.com)**















**Do not use thread lock:** Indicates that no liquid thread lock should be used at this point.



**Tighten by hand:** Indicates that the attachment must be carefully tightened by hand.

**PARTS LIST - READ AND KEEP MOUNTING INSTRUCTIONS!**

<b>1</b>						
	HDG.00.220.002L.02	HDG.00.220.002R.02	HDG.00.220.008L.02	HDG.00.220.008R.02	HDG.00.220.009.02	M3,5 x 12 SC.ST.035.012.02
	 1/1	 1/1	 1/1	 1/1	 4/4	 8/8



**▲ WARNING: Always wear eye and hand protection!**  
**▲ WARNING: Always use the proper tools!**

**△ NOTE:** Assembly is shown on the left side. Repeat the assembly with the corresponding parts on the right.

**△ NOTE:** Pay attention to the L marking (left) or R marking (right) of the plastic caps [3/4]. Insert the plastic caps [3/4] into the openings of the Adventure hand-guard shells [1/2].

Screw the Adventure hand-guard shells [1/2] onto the brackets [\*]. Carefully tighten the screws [5] hand-tight (max. 1 Nm).

**▲ WARNING: Tightening too tightly can damage the plastic parts!**

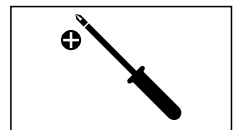
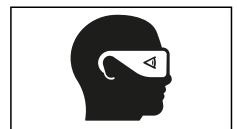
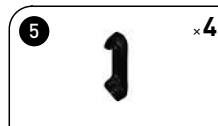

**PRODUCT-SPECIFIC NOTES**

**⚠ NOTE:** *Observe the country-specific regulations for the registration/operation of your vehicle or applicable TÜV regulations. After assembly, have parts that are subject to registration entered in the vehicle documents by your test centre.*