

# ANBAUANLEITUNG

mounting instructions • instructions de montage • instrucciones de montaje • istruzioni di montaggio

## BC.HTA.11.616.20100

beinhaltet • contains • contient • contiene • contiene

HTA.11.616.10000

HTA.11.616.11000

BC.HTA.00.402.10200L

BC.HTA.00.401.10200R

Item number: HTA.11.616.10000

Revision: 01 · Date: 08 - 2024

## SLC side carrier left

 ~ 0.5 h.

EASY      DIFFICULT

**ENGLISH** Thank you for choosing this premium product from SW-MOTECH. Visit our online shop for more information (e.g. model assignments). Required documents (e.g. national type approval) are available there for you to download.

Please read and understand all the instructions, safety information and warnings in these mounting instructions before mounting and using the product in order to avoid injury and damage. Keep these mounting instructions for reference.

This product was developed for vehicles in factory condition. Compatibility with original accessories or accessories from other manufacturers cannot be guaranteed.

These mounting instructions have been prepared to the best of our current knowledge. No legal claims relating to accuracy can be made. Errors and omissions excepted. We reserve the right to make technical and design changes. The copyright is held by SW-MOTECH.

### SAFETY WARNING SYMBOL

 This warning symbol is used in these mounting instructions to warn of deadly dangers, injuries or other hazards. The words **DANGER**, **WARNING** or **CAUTION** are used as part of this warning symbol to convey important safety messages and information relating to the installation and use of this product. These words, together with the safety warning symbol, mean:

 **DANGER:** Indicates a hazardous situation which, if not avoided, will result in death or serious injury!

 **WARNING:** Indicates a hazardous situation which, if not avoided, may result in death or serious injury!

 **CAUTION:** Indicates a hazardous situation which, if not avoided, may result in minor or moderate injury!

 **NOTE:** Important information, but not relating to a risk of death or injury (property damage only)!

### GENERAL INFORMATION

 **WARNING:** Assembly and/or maintenance of this product requires advanced technical skill, appropriate tools, and a good understanding of tool usage and torque specifications. For your own safety, SW-MOTECH recommends having the assembly and/or maintenance carried out by a qualified and certified motorcycle workshop.

 **WARNING:** If you do choose to assemble this product yourself, carefully and fully read the mounting instructions before assembly and use, and follow all instructions to avoid serious injury or death. Also observe all relevant information in the vehicle manual when mounting or using the product. IF YOU DO NOT UNDERSTAND ANY PART OF THESE MOUNTING INSTRUCTIONS OR NEED AN EXPLANATION AS TO A SPECIFIC INSTRUCTION, DO NOT ATTEMPT TO INSTALL THIS PRODUCT WITHOUT CONSULTING SW-MOTECH FOR ASSISTANCE!

**PREPARATION:** Read the mounting instructions carefully and make sure that all parts on the parts list are available.

 **CAUTION:** Ensure that your vehicle is standing securely. Switch off the engine and remove the ignition key. Allow the engine/exhaust to cool down if necessary. Disconnect the battery when working on the electrical system. Only use proper tools and always wear safety goggles and gloves during assembly and maintenance. Have a second person help you with assembly and maintenance.

**ASSEMBLY:** All parts and connections removed from the vehicle must be reinstalled according to the vehicle manufacturer's specifications or replaced with parts and hardware supplied by SW-MOTECH.

 **WARNING:** Secure all threads with a medium-strength liquid threadlocker, unless otherwise specified.

 **DANGER:** Tightening torques not defined by SW-MOTECH must be obtained from the vehicle manufacturer or a certified motorbike workshop.

**FUNCTIONAL CHECK:** After mounting the product, ensure that no moving parts are obstructed and that the function of the vehicle is not impeded. Cables and hoses must not rub against each other and/or be hindered in any way.

 **WARNING:** Carry out a comprehensive functionality check before you start to drive. Check the tightening torque of all connections and the tight fit of the product after the first 50 km and then at regular intervals. Mounted accessories can change the handling and stability of the vehicle.



SW-MOTECH GmbH & Co. KG  
Ernteweg 7-10  
35282 Rauschenberg  
Germany



 [info@sw-motech.com](mailto:info@sw-motech.com)  
 [www.sw-motech.com](http://www.sw-motech.com)

**LEGEND OVERVIEW - READ AND KEEP MOUNTING INSTRUCTIONS!**



Take note of the symbols and what they mean in the ASSEMBLY section. If the term OEM appears in the ASSEMBLY section, the vehicle manufacturer's specifications must be observed and applied.



If you have any questions, please don't hesitate to contact our Customer Service team or our distributors. You can find our telephone number and a list of our distributors in our online shop:

**[www.sw-motech.com](http://www.sw-motech.com)**



**Use thread locker:** Indicates that a thread must be coated with liquid thread locker. H (HIGH): high strength; M (MEDIUM): medium strength; L (LOW): low strength.



**Tighten/note the tightening torque information:**

Indicates the tightening torque of a part specified by SW-MOTECH or the vehicle manufacturer (OEM).

**PARTS LIST - READ AND KEEP MOUNTING INSTRUCTIONS!**

<p><b>2</b></p>	<p><b>1</b></p>  <p>HTA.11.616.900.01.11</p> <p> 1/1</p>	<p><b>2</b></p>  <p>M8 x 55; DIN 912 SC.ST.08.055.02.912.088</p> <p> 1/1</p>	<p><b>3</b></p>  <p>M8 x 70; DIN 912 SC.ST.08.070.02.912.088</p> <p> 1/1</p>	<p><b>4</b></p>  <p>ø 8,4; DIN 125 US.ST.084.02.125</p> <p> 2/2</p>	<p><b>5</b></p>  <p>Ø 20 / ø 8,4 / h 17 DB.ST.0200.0084.0170.02</p> <p> 1/1</p>	<p><b>6</b></p>  <p>Ø 20 / ø 8,4 / h 27 DB.ST.0200.0084.0270.02</p> <p> 1/1</p>
<p><b>3</b></p>	<p><b>7</b></p>  <p>HTA.00.152.080.35</p> <p> 3/3</p>	<p><b>8</b></p>  <p>HTA.00.152.081.00</p> <p> 1/1</p>	<p><b>9</b></p>  <p>M6 x 20; DIN 6912 SC.ST.06.020.01.6912.088</p> <p> 1/1</p>	<p><b>10</b></p>  <p>M6 x 20; DIN 7991 SC.ST.06.020.48.7991.109</p> <p> 2/2</p>		

1

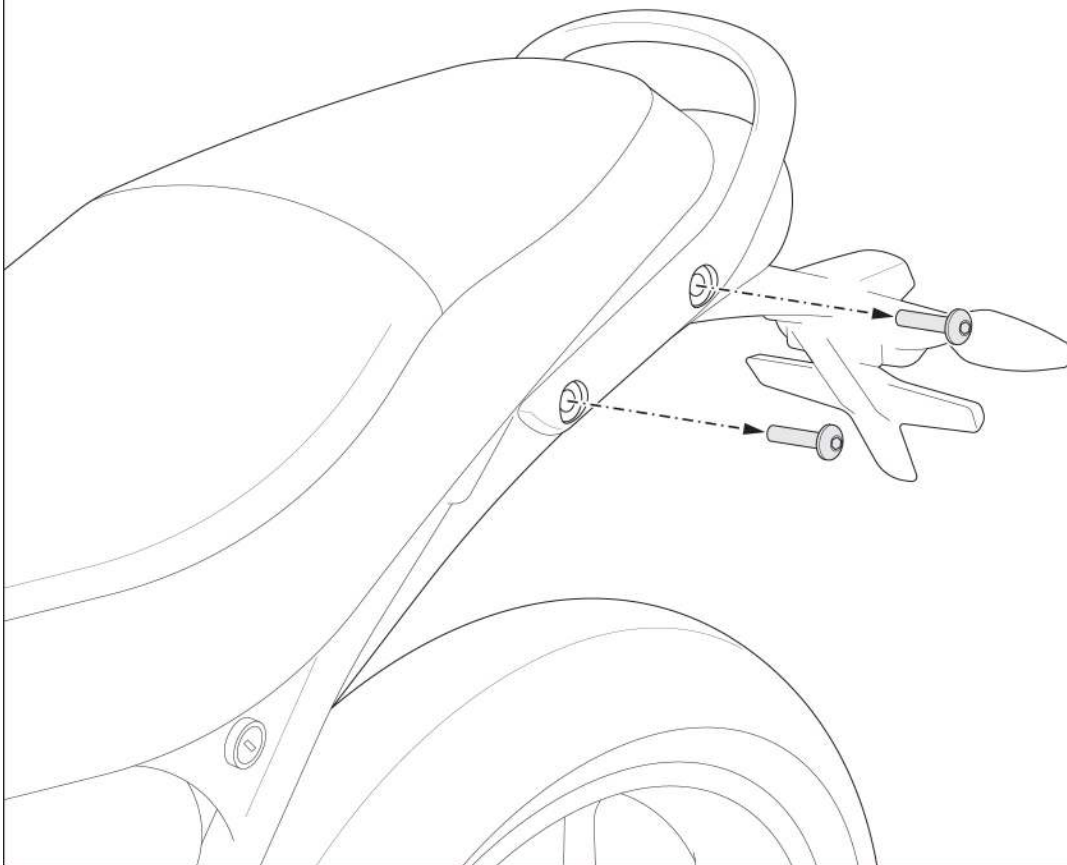

- ▲ **WARNING: Always wear eye and hand protection!**
- ▲ **WARNING: Always use the proper tools!**

Remove the original screws from the vehicle.

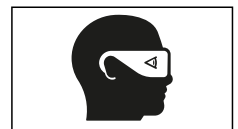

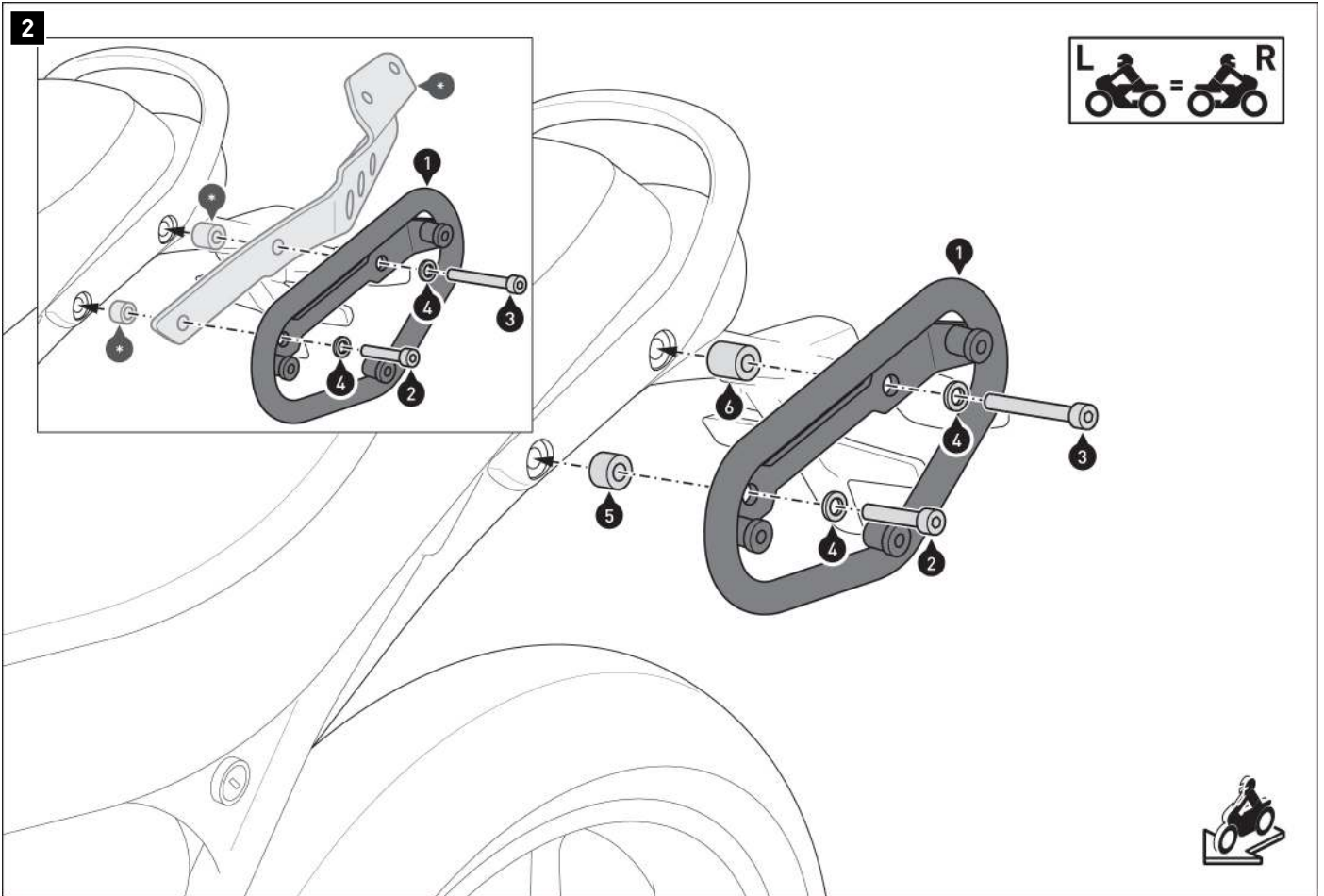

**⚠ NOTE:** If you are installing the luggage rack at the same time as the SW-MOTECH luggage rack (\*), screw the parts together as shown in the detailed drawing. Spacers (5) and (6) are not required. Instead, install the spacers (\*) included with the luggage rack.

Screw the side carrier (1) to the rear of the vehicle.

**⚠ WARNING: Use liquid threadlocker!**

Tighten screws (2) and (3) according to the vehicle manufacturer's specifications.

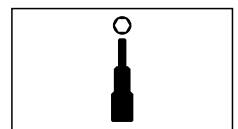
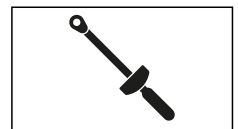

3

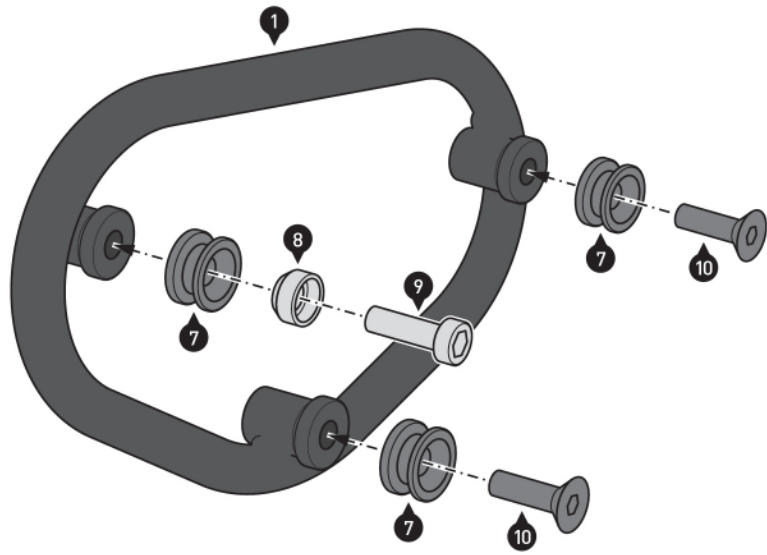
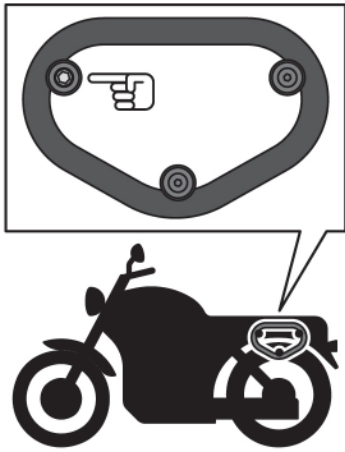

Screw parts [7] to [10] onto the side carrier [1].

**▲ WARNING: Use liquid threadlocker!**

Tighten the screws [9] and [10] as described in the mounting instructions.

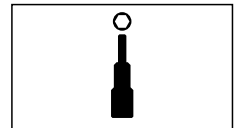
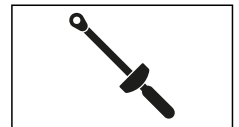

PRODUCT-SPECIFIC NOTES

**⚠ WARNING:** The mounting instructions enclosed with the saddlebags must be followed!

**⚠ NOTE:** Observe the country-specific regulations for registering/operating your vehicle or the applicable TÜV regulations. After assembly, have parts that are subject to registration entered in the vehicle documents by your test centre.



Item number: HTA.11.616.11000

Revision: 01 · Date: 08 - 2024

## SLC side carrier right

 ~ 0.5 h.

EASY      DIFFICULT

**ENGLISH** Thank you for choosing this premium product from SW-MOTECH. Visit our online shop for more information (e.g. model assignments). Required documents (e.g. national type approval) are available there for you to download.

Please read and understand all the instructions, safety information and warnings in these mounting instructions before mounting and using the product in order to avoid injury and damage. Keep these mounting instructions for reference.

This product was developed for vehicles in factory condition. Compatibility with original accessories or accessories from other manufacturers cannot be guaranteed.

These mounting instructions have been prepared to the best of our current knowledge. No legal claims relating to accuracy can be made. Errors and omissions excepted. We reserve the right to make technical and design changes. The copyright is held by SW-MOTECH.

### SAFETY WARNING SYMBOL

 This warning symbol is used in these mounting instructions to warn of deadly dangers, injuries or other hazards. The words **DANGER**, **WARNING** or **CAUTION** are used as part of this warning symbol to convey important safety messages and information relating to the installation and use of this product. These words, together with the safety warning symbol, mean:

 **DANGER:** Indicates a hazardous situation which, if not avoided, will result in death or serious injury!

 **WARNING:** Indicates a hazardous situation which, if not avoided, may result in death or serious injury!

 **CAUTION:** Indicates a hazardous situation which, if not avoided, may result in minor or moderate injury!

 **NOTE:** Important information, but not relating to a risk of death or injury (property damage only)!

### GENERAL INFORMATION

 **WARNING:** Assembly and/or maintenance of this product requires advanced technical skill, appropriate tools, and a good understanding of tool usage and torque specifications. For your own safety, SW-MOTECH recommends having the assembly and/or maintenance carried out by a qualified and certified motorcycle workshop.

 **WARNING:** If you do choose to assemble this product yourself, carefully and fully read the mounting instructions before assembly and use, and follow all instructions to avoid serious injury or death. Also observe all relevant information in the vehicle manual when mounting or using the product. IF YOU DO NOT UNDERSTAND ANY PART OF THESE MOUNTING INSTRUCTIONS OR NEED AN EXPLANATION AS TO A SPECIFIC INSTRUCTION, DO NOT ATTEMPT TO INSTALL THIS PRODUCT WITHOUT CONSULTING SW-MOTECH FOR ASSISTANCE!

**PREPARATION:** Read the mounting instructions carefully and make sure that all parts on the parts list are available.

 **CAUTION:** Ensure that your vehicle is standing securely. Switch off the engine and remove the ignition key. Allow the engine/exhaust to cool down if necessary. Disconnect the battery when working on the electrical system. Only use proper tools and always wear safety goggles and gloves during assembly and maintenance. Have a second person help you with assembly and maintenance.

**ASSEMBLY:** All parts and connections removed from the vehicle must be reinstalled according to the vehicle manufacturer's specifications or replaced with parts and hardware supplied by SW-MOTECH.

 **WARNING:** Secure all threads with a medium-strength liquid threadlocker, unless otherwise specified.

 **DANGER:** Tightening torques not defined by SW-MOTECH must be obtained from the vehicle manufacturer or a certified motorbike workshop.

**FUNCTIONAL CHECK:** After mounting the product, ensure that no moving parts are obstructed and that the function of the vehicle is not impeded. Cables and hoses must not rub against each other and/or be hindered in any way.

 **WARNING:** Carry out a comprehensive functionality check before you start to drive. Check the tightening torque of all connections and the tight fit of the product after the first 50 km and then at regular intervals. Mounted accessories can change the handling and stability of the vehicle.



SW-MOTECH GmbH & Co. KG  
Ernteweg 7-10  
35282 Rauschenberg  
Germany



 [info@sw-motech.com](mailto:info@sw-motech.com)  
 [www.sw-motech.com](http://www.sw-motech.com)



Take note of the symbols and what they mean in the ASSEMBLY section. If the term OEM appears in the ASSEMBLY section, the vehicle manufacturer's specifications must be observed and applied.



If you have any questions, please don't hesitate to contact our Customer Service team or our distributors. You can find our telephone number and a list of our distributors in our online shop:

**[www.sw-motech.com](http://www.sw-motech.com)**



**Use thread locker:** Indicates that a thread must be coated with liquid thread locker. H (HIGH): high strength; M (MEDIUM): medium strength; L (LOW): low strength.



**Tighten/note the tightening torque information:**

Indicates the tightening torque of a part specified by SW-MOTECH or the vehicle manufacturer (OEM).

**PARTS LIST - READ AND KEEP MOUNTING INSTRUCTIONS!**

<p><b>2</b></p>	<p><b>1</b></p>  <p>HTA.11.616.900.01.11</p> <p> 1/1</p>	<p><b>2</b></p>  <p>M8 x 55; DIN 912 SC.ST.08.055.02.912.088</p> <p> 1/1</p>	<p><b>3</b></p>  <p>M8 x 70; DIN 912 SC.ST.08.070.02.912.088</p> <p> 1/1</p>	<p><b>4</b></p>  <p>ø 8,4; DIN 125 US.ST.084.02.125</p> <p> 2/2</p>	<p><b>5</b></p>  <p>Ø 20 / ø 8,4 / h 17 DB.ST.0200.0084.0170.02</p> <p> 1/1</p>	<p><b>6</b></p>  <p>Ø 20 / ø 8,4 / h 27 DB.ST.0200.0084.0270.02</p> <p> 1/1</p>
<p><b>3</b></p>	<p><b>7</b></p>  <p>HTA.00.152.080.35</p> <p> 3/3</p>	<p><b>8</b></p>  <p>HTA.00.152.081.00</p> <p> 1/1</p>	<p><b>9</b></p>  <p>M6 x 20; DIN 6912 SC.ST.06.020.01.6912.088</p> <p> 1/1</p>	<p><b>10</b></p>  <p>M6 x 20; DIN 7991 SC.ST.06.020.48.7991.109</p> <p> 2/2</p>		

1

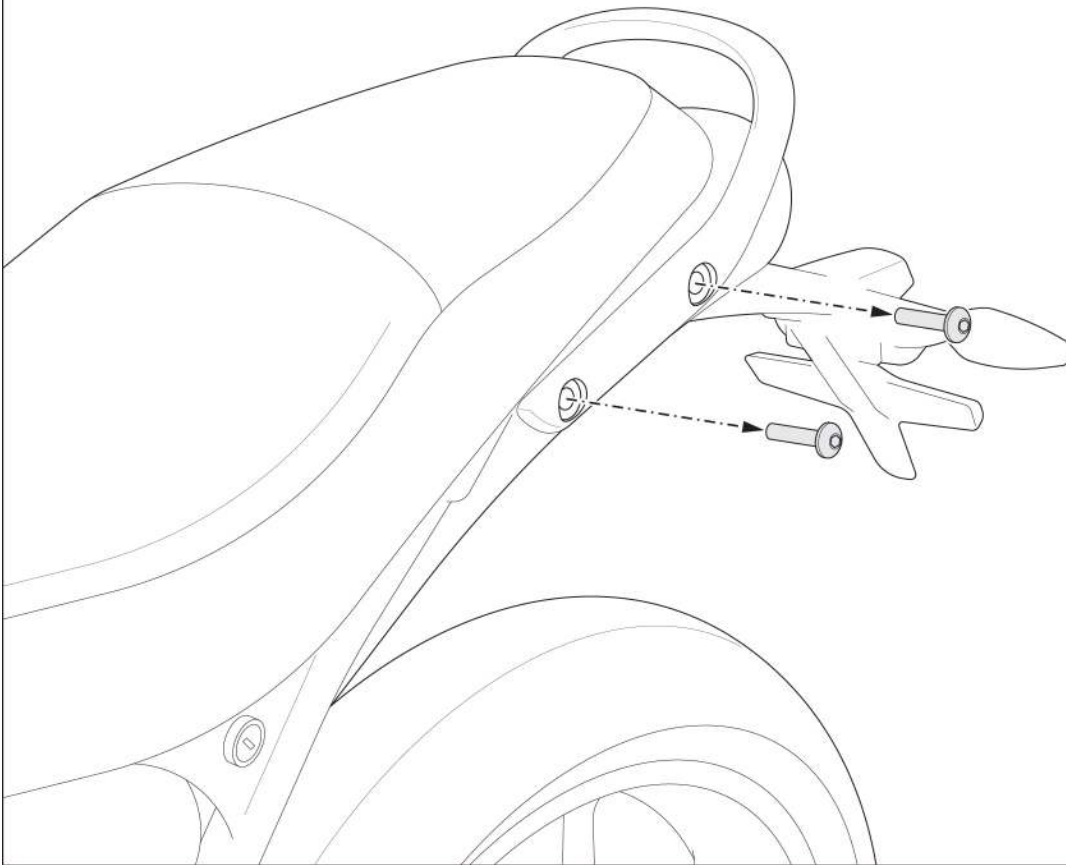

- ▲ **WARNING:** Always wear eye and hand protection!
- ▲ **WARNING:** Always use the proper tools!

▲ **NOTE:** The following installation steps show the installation of the left side carrier. Install the right side carrier in the same way.

Remove the original screws from the vehicle.

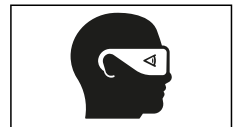

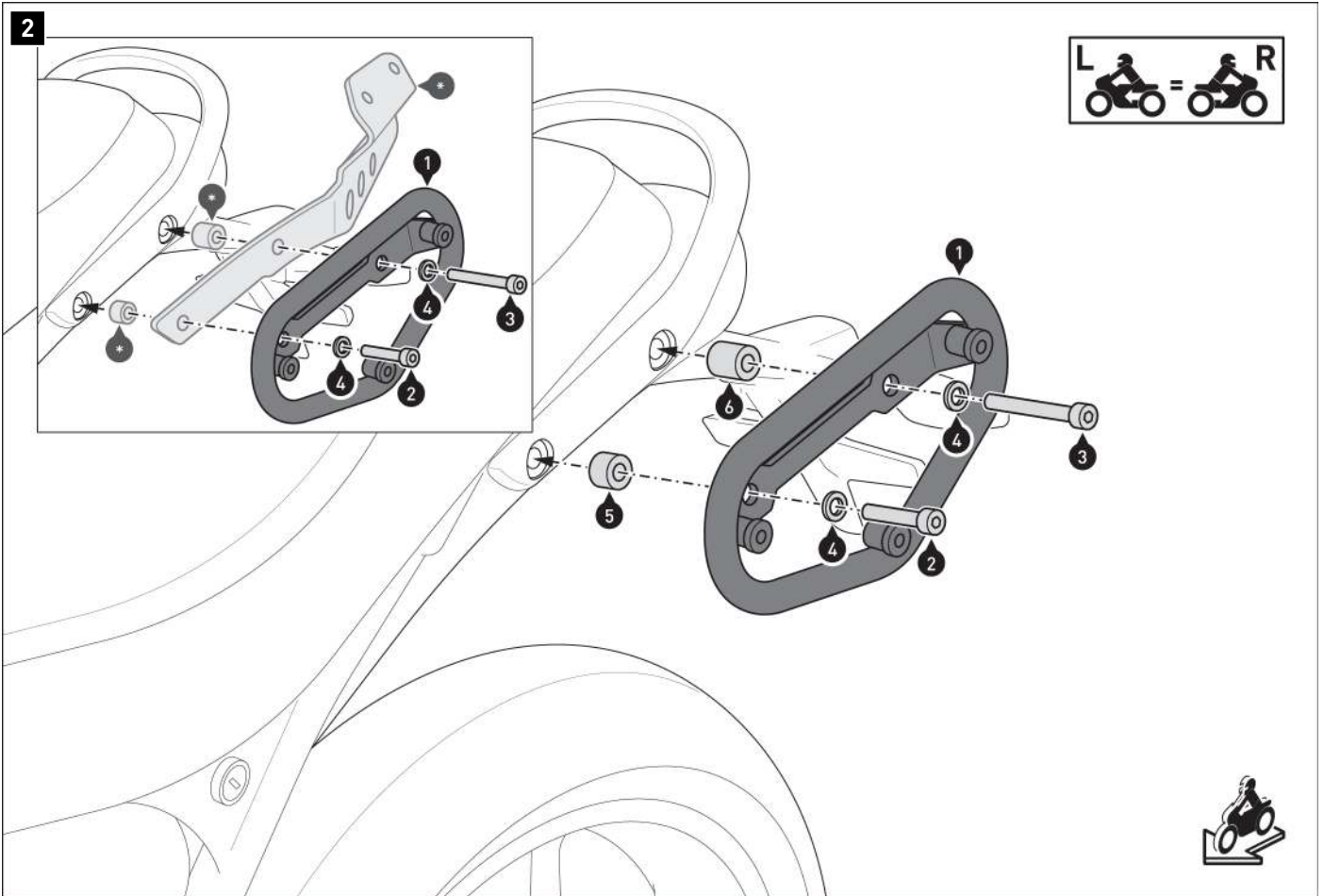

**⚠ NOTE:** If you are installing the luggage rack at the same time as the SW-MOTECH luggage rack (\*), screw the parts together as shown in the detailed drawing. Spacers (5) and (6) are not required. Instead, install the spacers (\*) included with the luggage rack.

Screw the side carrier (1) to the rear of the vehicle.

**⚠ WARNING: Use liquid threadlocker!**

Tighten screws (2) and (3) according to the vehicle manufacturer's specifications.

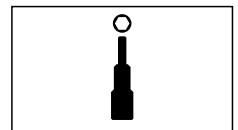
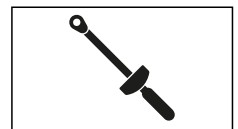

3

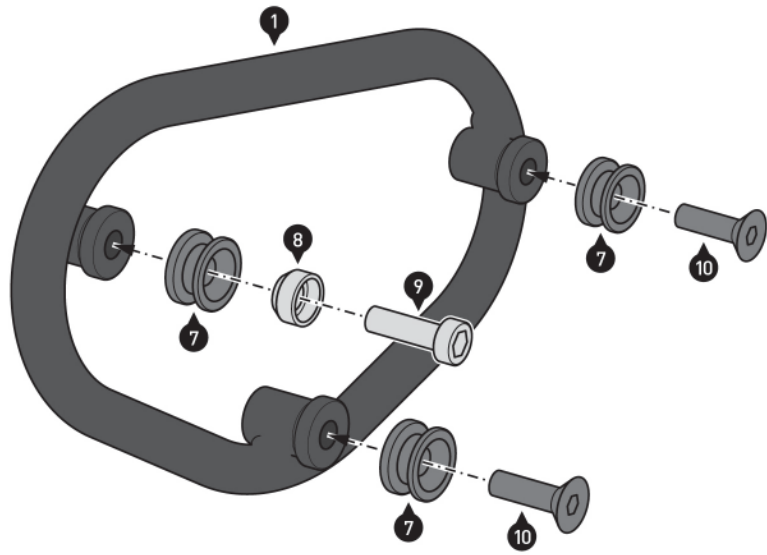
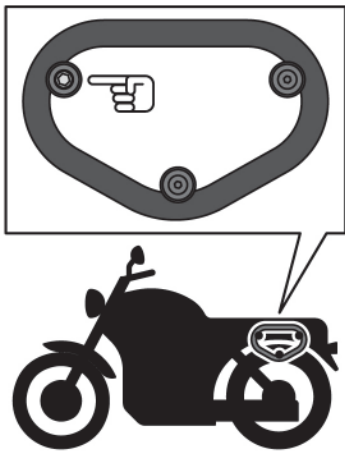

Screw parts [7] to [10] onto the side carrier [1].

**▲ WARNING: Use liquid threadlocker!**

Tighten the screws [9] and [10] as described in the mounting instructions.

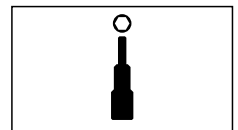
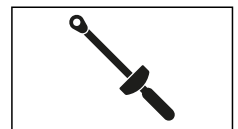

**PRODUCT-SPECIFIC NOTES**

**⚠ WARNING:** The mounting instructions enclosed with the saddlebags must be followed!

**⚠ NOTE:** Observe the country-specific regulations for registering/operating your vehicle or the applicable TÜV regulations. After assembly, have parts that are subject to registration entered in the vehicle documents by your test centre.

**Legend Gear Seitentasche LC1 / LC2****Legend Gear Side Bag LC1 / LC2**

**DEUTSCH** - Vielen Dank, dass Sie sich für dieses Premiumprodukt von SW-MOTECH entschieden haben.

☞ Bitte besuchen Sie unseren Webshop für weitere Informationen wie Modellzuweisungen und PDF-Anleitung. Erforderliche Dokumente (z. B. ABE) stehen als Download zur Verfügung. >> [www.sw-motech.com](http://www.sw-motech.com)

Beachten Sie unbedingt alle in der Anbauanleitung angegebenen Hinweise. Beachten Sie außerdem alle für die Montage relevanten Hinweise im Fahrzeughandbuch. Nichtbeachtung kann zu Schäden am Fahrzeug bzw. zur Gefährdung des Fahrers führen! Bitte heben Sie die Anbauanleitung als Referenz auf. SW-MOTECH übernimmt keine Haftung für Schäden, die durch eine unsachgemäße Befestigung und Handhabung verursacht wurden.

Dieses Produkt wurde für Fahrzeuge im Originalzustand entwickelt. Die Kompatibilität mit originalen Zubehörteilen bzw. den Zubehörteilen anderer Hersteller kann nicht gewährleistet werden. Montiertes Zubehör kann das Fahrverhalten und/oder die Stabilität Ihres Fahrzeugs verändern.

**ALLGEMEINE HINWEISE**

Bitte beachten Sie landesspezifische Vorschriften für Zulassung oder Betrieb Ihres Fahrzeugs.

**VORBEREITUNG:** Lesen Sie aufmerksam die Anbauanleitung und stellen Sie sicher, dass alle Teile der Stückliste vorhanden sind. Achten Sie darauf, dass Ihr Fahrzeug sicher steht und nicht umfallen kann. Schalten Sie den Motor ab und ziehen Sie den Zündschlüssel. Lassen Sie ggf. den Motor/Auspuff abkühlen. Achten Sie darauf, nur geeignetes Werkzeug zu verwenden. Lassen Sie sich bei den Montagearbeiten von einer zweiten Person helfen.

**FUNKTIONSKONTROLLE:** Da es sich um ein universelles Produkt handelt, stellen Sie unbedingt VOR der ersten Nutzung sicher, dass sich das Produkt ohne Probleme und sachgerecht an Ihrem Fahrzeugtyp befestigen und verwenden lässt.

**ACHTUNG:** Achten Sie darauf, dass keine Komponenten des Produkts mit heißen und beweglichen Teilen des Fahrzeugs in Kontakt kommen können. Achten Sie desweiteren darauf, dass alle Komponenten mindestens 5 cm Abstand zu heißen Teilen sowie dem heißen Abgasstrom des Auspuffs haben. Stellen Sie nach erfolgter Montage sicher, dass dieser Abstand in jedem Federzustand des Fahrzeugs eingehalten wird.

**ACHTUNG:** Überprüfen Sie vor Fahrtbeginn und bei jeder Rast (alle 200 km) den ordnungsgemäßen Sitz des Produkts!

Achten Sie nach der Befestigung auf die uneingeschränkte Freigängigkeit und einwandfreie Funktion sämtlicher Fahrzeugteile. Leuchtmittel wie Rücklicht und Blinker dürfen nicht in ihrer Funktion eingeschränkt werden. Kabel, Züge und Schläuche dürfen nicht scheuern und/oder geklemmt werden. Führen Sie vor Fahrtbeginn eine umfassende Funktionskontrolle durch.

**BELADUNGSINFORMATIONEN**

**ACHTUNG:** Das Fahr-/Bremsverhalten des Motorrads verändert sich nach Befestigung dieses Produkts merklich! Achten Sie auf die gleichmäßige Verteilung der Ladung!

**ACHTUNG:** Je nach Ort der Befestigung kann die Kurven- und Bodenfreiheit durch dieses Produkt eingeschränkt werden!

Achten Sie darauf, niemals scharfkantige, spitze oder ähnliche Gegenstände zu verpacken, welche Verletzungen an Personen bzw. Beschädigungen am Fahrzeug/Produkt verursachen könnten.

Verwenden Sie eine wasserdichte Innentasche/Regenhaube, um Ihr Gepäck vor Feuchtigkeit zu schützen. Schützen Sie empfindliches Gepäck (z. B. elektronische Geräte) zusätzlich mit einer Plastiktüte vor Feuchtigkeit.

**ACHTUNG:** Maximale Zuladung: 5 kg! Es gilt die vom Fahrzeughersteller genannte maximale Zuladung des Fahrzeugs!

**ATTENTION:** Höchstgeschwindigkeit mit diesem Produkt: 130 km/h!

**ENGLISH** - Thank you for choosing this premium product from SW-MOTECH.

☞ Please visit our webshop for additional information, such as application charts and PDF mounting instructions. Any other documents that may be required (e.g. ABE certifications), are also available for download at our webshop. >> [www.sw-motech.com](http://www.sw-motech.com)

Carefully follow all the directions given in the mounting instructions. Also pay attention to all relevant information in the vehicle manual during assembly. Nonconformance can lead to vehicle damage or even endanger the driver! Please keep the mounting instructions as reference. SW-MOTECH assumes no liability for damages caused by improper fixation and handling.

This product was developed for vehicles in their original condition. Compatibility with original accessory parts or other manufacturers' accessory parts is not guaranteed. Installed accessories can change driving behaviour and/or stability of your vehicle.

**GENERAL INFORMATION**

Please observe any country-specific regulations concerning vehicle registration.

**PREPARATION:** Read the mounting instructions carefully and make sure that all parts are included. Make sure that your vehicle is parked safely and cannot fall over. Turn off the engine and remove the ignition key. Let the motor/exhaust cool off if necessary. Make sure to use only the appropriate tools. During installation have another person help you.

**FUNCTION CHECK:** This is a universal product. For this reason make sure BEFORE the first use, that the product can be fixed properly and used without problems with your vehicle type.

**ATTENTION:** All components of the product must not contact any hot or moving parts of the vehicle. All parts should also remain 5 cm away from hot parts of the vehicle and remain clear of the exhaust stream. After mounting, make sure there are no clearance issues while the suspension is both compressed and extended.

**ATTENTION:** Before riding and at each stop (every 200 km) check proper fixation of the product!

After fixation also make sure that no moving parts are obstructed and the function of the vehicle is not hindered in any way. Lamps as taillight and turn signals must not be limited in their function. Cables and hoses must not rub and/or be pinched. Before starting to ride, perform a comprehensive check of all functions.

**LOADING INFORMATION**

**ATTENTION:** Riding with this product may affect the motorcycles driving and braking performance! Make sure weight is evenly distributed!

**ATTENTION:** Depending on the location of fixation, cornering and ground clearance can be reduced by using this product!

Never store pointy or sharp-edged objects in the product, which could cause injury to persons or damage to the vehicle/product.

Use a waterproof inner bag/raincover to protect your luggage from moisture. Additionally protect sensitive luggage (e.g., electronic equipment) from moisture with a plastic bag.

**ATTENTION:** Maximum load: 5 kg / 11 lbs! The maximum vehicle load specified by the manufacturer must not be exceeded!

**ATTENTION:** Maximum speed with this product: 130 km/h!

**SW-MOTECH GmbH & Co. KG**

Ernteweg 8/10 · 35282 Rauschenberg · Germany

Tel. / phone + 49 (0)6425 / 8168 - 050

Fax / fax + 49 (0)6425 / 8168 - 10

[info@sw-motech.com](mailto:info@sw-motech.com) · [www.sw-motech.com](http://www.sw-motech.com)







1a 1x Seitentasche LC1  
Side Bag LC1  
BC.HTA.00.401.10+00 L / R



1b 1x Seitentasche LC2  
Side Bag LC2  
BC.HTA.00.402.10+00 L / R



2 1x Wasserdichte Innentasche  
Waterproof Innerbag



Features (von links nach rechts): Schnellverschluss-System; Laschen für den Schultergurt (separat erhältlich); Wasserdichte Innentasche.  
Features (from left to right): Quick release fastening system; Loops for the shoulder strap (sold separately); Waterproof Innerbag.

**PFLEGE**

Reinigen Sie das Produkt in regelmäßigen Abständen bzw. nach jeder Fahrt, da Staub und Schmutz einen verschleißenden Effekt haben und dauerhafte Flecken so verhindert werden können. Reinigen Sie das Produkt unbedingt nach Winterfahrten, um Schäden durch Salz zu vermeiden.

Entfernen Sie zunächst Staub und Verkrustungen mit einer weichen Textilbürste. Mit einem weichen Tuch und warmer Seifenlauge können hartnäckige Ablagerungen entfernt werden. Verwenden Sie KEINE scharfen Reinigungsmittel, raue Putzutensilien oder einen Hochdruckreiniger! Spülen Sie anschließend mit klarem Wasser nach.

Lassen Sie das Produkt vor Wiederverwendung mindesten 24 Stunden an der Luft trocken (nicht in direkter Sonneneinstrahlung).

Wir empfehlen, die Baumwolltextiloberfläche des Produkts in regelmäßigen Abständen bzw. nach intensiver Reinigung mit einer handelsüblichen Wachsimprägnierung (z. B. von Fjällräven) zu imprägnieren.

**ACHTUNG:** Da es sich bei dem textilen Oberflächenmaterial um eine Naturfaser handelt, wird es bei längerer und intensiver Sonneneinstrahlung und Umwelteinflüssen (z. B. SMOG, saurer Regen, etc.) zu Farbveränderungen (Ausbleichen) kommen! Dafür übernimmt SW-MOTECH keine Haftung!

**ACHTUNG:** Verschmutzungen am Produkt und Fahrzeug haben einen Schleifeffekt und können Oberflächen wie die Lackierung beschädigen. Achten Sie darauf, dass alle Bereiche des Fahrzeugs, auf denen das Produkt oder Teile des Produkts wie Halteriemen aufliegen, mit einer Lackschutzfolie vor Kratzern und Abrieb geschützt werden. Für Lackschäden und Abrieb übernimmt SW-MOTECH keine Haftung.

**CARE**

Clean the product periodically or after each trip, as dust and dirt have a wear-effect and permanent stains can be prevented. Clean the product after riding in salty conditions, to avoid damage from salt.

First remove dust and encrustations with a soft dry brush. Remove stubborn deposits with a soft cloth and warm soapy water. Do NOT use strong cleaning agents, rough cleaning tools or high pressure washer! Then rinse with clear water.

Before re-use dry the product for at least 24 hours in the air (not in direct sunlight).

We recommend to impregnate the cotton textile surface of the product in regular intervals or after intensive cleaning with a commercial wax impregnation (e.g. from Fjällräven).

**ATTENTION:** Because the textile surfaces material is a natural fiber, it will experience color changes or fading when exposed to direct sunlight for extended periods of time and by environmental factors (e.g., SMOG, acid rain, etc.)! SW-MOTECH assumes no liability for this!

**ATTENTION:** Dirt on the product and vehicle has an abrasive effect and can damage surfaces, such as the paint. Make sure that all areas of the vehicle, which have contact with the product or parts of the product as straps, are protected with an adhesive protection film from scratches and abrasions. SW-MOTECH assumes no liability for paint damage and abrasions.

1/



Schließen Sie den Klettverschluss der Seitentasche (1a/1b).  
Schlagen Sie die verstärkte Öffnung der Seitentasche (1a/1b) zweimal vollständig um.

Fasten the Velcro closure of the side bag (1a/1b).  
Revert the reinforced opening of the side bag (1a/1b) twice completely.

2/



Fixieren Sie die gezeigten Laschen mit den seitlich angebrachten Hakenschnallen.

Fix the shown loops with the side-mounted hook buckles.

3/



Ziehen Sie anschließend die Gurte der Hakenschnallen fest an.

Sichern Sie abschließend die Öffnung der Seitentasche (1a/1b) mit dem gezeigten Gurt.

Tighten the straps of the hook buckle.

Secure the opening of the side bag (1a/1b) with the shown strap.

4 /



Befestigung und Fahrzeug dienen als Beispiel. / Fixation and vehicle are examples.

Setzen Sie die drei Öffnungen des Schnellverschluss-Systems auf die Aufnahmebolzen des montierten SLC Seitenträgers.

Place the three openings of the quick release fastening system on the locating bolts of the mounted SLC side carrier.

5 /



Befestigung und Fahrzeug dienen als Beispiel. / Fixation and vehicle are examples.

Drücken Sie anschließend die Seitentasche (1a/1b) leicht nach unten, bis diese fest am SLC Seitenträger sitzt.

**ACHTUNG: Achten Sie darauf, dass alle drei Aufnahmebolzen gleichzeitig einrasten!**  
Achten Sie außerdem auf das deutlich hörbare Einrastgeräusch des Verschlussmechanismus!

Press the side bag (1a/1b) slightly downward, until it properly rests on SLC side carrier.

**ATTENTION: Make sure that all three locating bolts engage at the same time!**  
Pay attention to the clearly audible snap sound of the locking mechanism!

6 /



Befestigung und Fahrzeug dienen als Beispiel. / Fixation and vehicle are examples.

Drücken Sie zum Entriegeln der Seitentasche (1a/1b) einfach den gezeigten Schieber des Verschlussmechanismus nach unten.

To release the side bag (1a/1b) simply press the shown slider of the locking mechanism downward.

## Legend Gear Seitentasche LC1 / LC2

## Legend Gear Side Bag LC1 / LC2

**DEUTSCH** - Vielen Dank, dass Sie sich für dieses Premiumprodukt von SW-MOTECH entschieden haben.

☞ Bitte besuchen Sie unseren Webshop für weitere Informationen wie Modellzuweisungen und PDF-Anleitung. Erforderliche Dokumente (z. B. ABE) stehen als Download zur Verfügung. >> [www.sw-motech.com](http://www.sw-motech.com)

Beachten Sie unbedingt alle in der Anbauanleitung angegebenen Hinweise. Beachten Sie außerdem alle für die Montage relevanten Hinweise im Fahrzeughandbuch. Nichtbeachtung kann zu Schäden am Fahrzeug bzw. zur Gefährdung des Fahrers führen! Bitte heben Sie die Anbauanleitung als Referenz auf. SW-MOTECH übernimmt keine Haftung für Schäden, die durch eine unsachgemäße Befestigung und Handhabung verursacht wurden.

Dieses Produkt wurde für Fahrzeuge im Originalzustand entwickelt. Die Kompatibilität mit originalen Zubehörteilen bzw. den Zubehörteilen anderer Hersteller kann nicht gewährleistet werden. Montiertes Zubehör kann das Fahrverhalten und/oder die Stabilität Ihres Fahrzeugs verändern.

## ALLGEMEINE HINWEISE

Bitte beachten Sie landesspezifische Vorschriften für Zulassung oder Betrieb Ihres Fahrzeugs.

**VORBEREITUNG:** Lesen Sie aufmerksam die Anbauanleitung und stellen Sie sicher, dass alle Teile der Stückliste vorhanden sind. Achten Sie darauf, dass Ihr Fahrzeug sicher steht und nicht umfallen kann. Schalten Sie den Motor ab und ziehen Sie den Zündschlüssel. Lassen Sie ggf. den Motor/Auspuff abkühlen. Achten Sie darauf, nur geeignetes Werkzeug zu verwenden. Lassen Sie sich bei den Montagearbeiten von einer zweiten Person helfen.

**FUNKTIONSKONTROLLE:** Da es sich um ein universelles Produkt handelt, stellen Sie unbedingt VOR der ersten Nutzung sicher, dass sich das Produkt ohne Probleme und sachgerecht an Ihrem Fahrzeugtyp befestigen und verwenden lässt.

**ACHTUNG:** Achten Sie darauf, dass keine Komponenten des Produkts mit heißen und beweglichen Teilen des Fahrzeugs in Kontakt kommen können. Achten Sie desweiteren darauf, dass alle Komponenten mindestens 5 cm Abstand zu heißen Teilen sowie dem heißen Abgasstrom des Auspuffs haben. Stellen Sie nach erfolgter Montage sicher, dass dieser Abstand in jedem Federzustand des Fahrzeugs eingehalten wird.

**ACHTUNG:** Überprüfen Sie vor Fahrtbeginn und bei jeder Rast (alle 200 km) den ordnungsgemäßen Sitz des Produkts!

Achten Sie nach der Befestigung auf die uneingeschränkte Freigängigkeit und einwandfreie Funktion sämtlicher Fahrzeugteile. Leuchtmittel wie Rücklicht und Blinker dürfen nicht in ihrer Funktion eingeschränkt werden. Kabel, Züge und Schläuche dürfen nicht scheuern und/oder geklemmt werden. Führen Sie vor Fahrtbeginn eine umfassende Funktionskontrolle durch.

## BELADUNGSINFORMATIONEN

**ACHTUNG:** Das Fahr-/Bremsverhalten des Motorrads verändert sich nach Befestigung dieses Produkts merklich! Achten Sie auf die gleichmäßige Verteilung der Ladung!

**ACHTUNG:** Je nach Ort der Befestigung kann die Kurven- und Bodenfreiheit durch dieses Produkt eingeschränkt werden!

Achten Sie darauf, niemals scharfkantige, spitze oder ähnliche Gegenstände zu verpacken, welche Verletzungen an Personen bzw. Beschädigungen am Fahrzeug/Produkt verursachen könnten.

Verwenden Sie eine wasserdichte Innentasche/Regenhaube, um Ihr Gepäck vor Feuchtigkeit zu schützen. Schützen Sie empfindliches Gepäck (z. B. elektronische Geräte) zusätzlich mit einer Plastiktüte vor Feuchtigkeit.

**ACHTUNG:** Maximale Zuladung: 5 kg! Es gilt die vom Fahrzeughersteller genannte maximale Zuladung des Fahrzeugs!

**ATTENTION:** Höchstgeschwindigkeit mit diesem Produkt: 130 km/h!

**ENGLISH** - Thank you for choosing this premium product from SW-MOTECH.

☞ Please visit our webshop for additional information, such as application charts and PDF mounting instructions. Any other documents that may be required (e.g. ABE certifications), are also available for download at our webshop. >> [www.sw-motech.com](http://www.sw-motech.com)

Carefully follow all the directions given in the mounting instructions. Also pay attention to all relevant information in the vehicle manual during assembly. Nonconformance can lead to vehicle damage or even endanger the driver! Please keep the mounting instructions as reference. SW-MOTECH assumes no liability for damages caused by improper fixation and handling.

This product was developed for vehicles in their original condition. Compatibility with original accessory parts or other manufacturers' accessory parts is not guaranteed. Installed accessories can change driving behaviour and/or stability of your vehicle.

## GENERAL INFORMATION

Please observe any country-specific regulations concerning vehicle registration.

**PREPARATION:** Read the mounting instructions carefully and make sure that all parts are included. Make sure that your vehicle is parked safely and cannot fall over. Turn off the engine and remove the ignition key. Let the motor/exhaust cool off if necessary. Make sure to use only the appropriate tools. During installation have another person help you.

**FUNCTION CHECK:** This is a universal product. For this reason make sure BEFORE the first use, that the product can be fixed properly and used without problems with your vehicle type.

**ATTENTION:** All components of the product must not contact any hot or moving parts of the vehicle. All parts should also remain 5 cm away from hot parts of the vehicle and remain clear of the exhaust stream. After mounting, make sure there are no clearance issues while the suspension is both compressed and extended.

**ATTENTION:** Before riding and at each stop (every 200 km) check proper fixation of the product!

After fixation also make sure that no moving parts are obstructed and the function of the vehicle is not hindered in any way. Lamps as taillight and turn signals must not be limited in their function. Cables and hoses must not rub and/or be pinched. Before starting to ride, perform a comprehensive check of all functions.

## LOADING INFORMATION

**ATTENTION:** Riding with this product may affect the motorcycles driving and braking performance! Make sure weight is evenly distributed!

**ATTENTION:** Depending on the location of fixation, cornering and ground clearance can be reduced by using this product!

Never store pointy or sharp-edged objects in the product, which could cause injury to persons or damage to the vehicle/product.

Use a waterproof inner bag/raincover to protect your luggage from moisture. Additionally protect sensitive luggage (e.g., electronic equipment) from moisture with a plastic bag.

**ATTENTION:** Maximum load: 5 kg / 11 lbs! The maximum vehicle load specified by the manufacturer must not be exceeded!

**ATTENTION:** Maximum speed with this product: 130 km/h!

## SW-MOTECH GmbH &amp; Co. KG

Ernteweg 8/10 · 35282 Rauschenberg · Germany

Tel. / phone + 49 (0)6425 / 8168 - 050

Fax / fax + 49 (0)6425 / 8168 - 10

[info@sw-motech.com](mailto:info@sw-motech.com) · [www.sw-motech.com](http://www.sw-motech.com)





1a 1x Seitentasche LC1  
Side Bag LC1  
BC.HTA.00.401.10+00 L / R



1b 1x Seitentasche LC2  
Side Bag LC2  
BC.HTA.00.402.10+00 L / R



2 1x Wasserdichte Innentasche  
Waterproof Innerbag



Features (von links nach rechts): Schnellverschluss-System; Laschen für den Schultergurt (separat erhältlich); Wasserdichte Innentasche.  
Features (from left to right): Quick release fastening system; Loops for the shoulder strap (sold separately); Waterproof Innerbag.

**PFLEGE**

Reinigen Sie das Produkt in regelmäßigen Abständen bzw. nach jeder Fahrt, da Staub und Schmutz einen verschleißenden Effekt haben und dauerhafte Flecken so verhindert werden können. Reinigen Sie das Produkt unbedingt nach Winterfahrten, um Schäden durch Salz zu vermeiden.

Entfernen Sie zunächst Staub und Verkrustungen mit einer weichen Textilbürste. Mit einem weichen Tuch und warmer Seifenlauge können hartnäckige Ablagerungen entfernt werden. Verwenden Sie KEINE scharfen Reinigungsmittel, raue Putzutensilien oder einen Hochdruckreiniger! Spülen Sie anschließend mit klarem Wasser nach.

Lassen Sie das Produkt vor Wiederverwendung mindesten 24 Stunden an der Luft trocken (nicht in direkter Sonneneinstrahlung).

Wir empfehlen, die Baumwolltextiloberfläche des Produkts in regelmäßigen Abständen bzw. nach intensiver Reinigung mit einer handelsüblichen Wachsimprägnierung (z. B. von Fjällräven) zu imprägnieren.

**ACHTUNG:** Da es sich bei dem textilen Oberflächenmaterial um eine Naturfaser handelt, wird es bei längerer und intensiver Sonneneinstrahlung und Umwelteinflüssen (z. B. SMOG, saurer Regen, etc.) zu Farbveränderungen (Ausbleichen) kommen! Dafür übernimmt SW-MOTECH keine Haftung!

**ACHTUNG:** Verschmutzungen am Produkt und Fahrzeug haben einen Schleifeffekt und können Oberflächen wie die Lackierung beschädigen. Achten Sie darauf, dass alle Bereiche des Fahrzeugs, auf denen das Produkt oder Teile des Produkts wie Halteriemen aufliegen, mit einer Lackschutzfolie vor Kratzern und Abrieb geschützt werden. Für Lackschäden und Abrieb übernimmt SW-MOTECH keine Haftung.

**CARE**

Clean the product periodically or after each trip, as dust and dirt have a wear-effect and permanent stains can be prevented. Clean the product after riding in salty conditions, to avoid damage from salt.

First remove dust and encrustations with a soft dry brush. Remove stubborn deposits with a soft cloth and warm soapy water. Do NOT use strong cleaning agents, rough cleaning tools or high pressure washer! Then rinse with clear water.

Before re-use dry the product for at least 24 hours in the air (not in direct sunlight).

We recommend to impregnate the cotton textile surface of the product in regular intervals or after intensive cleaning with a commercial wax impregnation (e.g. from Fjällräven).

**ATTENTION:** Because the textile surfaces material is a natural fiber, it will experience color changes or fading when exposed to direct sunlight for extended periods of time and by environmental factors (e.g., SMOG, acid rain, etc.)! SW-MOTECH assumes no liability for this!

**ATTENTION:** Dirt on the product and vehicle has an abrasive effect and can damage surfaces, such as the paint. Make sure that all areas of the vehicle, which have contact with the product or parts of the product as straps, are protected with an adhesive protection film from scratches and abrasions. SW-MOTECH assumes no liability for paint damage and abrasions.

## BEFESTIGUNG / FIXATION

1/



Schließen Sie den Klettverschluss der Seitentasche (1a/1b).  
Schlagen Sie die verstärkte Öffnung der Seitentasche (1a/1b) zweimal vollständig um.

Fasten the Velcro closure of the side bag (1a/1b).  
Revert the reinforced opening of the side bag (1a/1b) twice completely.

2/



Fixieren Sie die gezeigten Laschen mit den seitlich angebrachten Hakenschnallen.

Fix the shown loops with the side-mounted hook buckles.

3/



Ziehen Sie anschließend die Gurte der Hakenschnallen fest an.  
Sichern Sie abschließend die Öffnung der Seitentasche (1a/1b) mit dem gezeigten Gurt.

Tighten the straps of the hook buckle.  
Secure the opening of the side bag (1a/1b) with the shown strap.

4 /



Befestigung und Fahrzeug dienen als Beispiel. / Fixation and vehicle are examples.

Setzen Sie die drei Öffnungen des Schnellverschluss-Systems auf die Aufnahmebolzen des montierten SLC Seitenträgers.

Place the three openings of the quick release fastening system on the locating bolts of the mounted SLC side carrier.

5 /



Befestigung und Fahrzeug dienen als Beispiel. / Fixation and vehicle are examples.

Drücken Sie anschließend die Seitentasche (1a/1b) leicht nach unten, bis diese fest am SLC Seitenträger sitzt.

**ACHTUNG: Achten Sie darauf, dass alle drei Aufnahmebolzen gleichzeitig einrasten!**  
Achten Sie außerdem auf das deutlich hörbare Einrastgeräusch des Verschlussmechanismus!

Press the side bag (1a/1b) slightly downward, until it properly rests on SLC side carrier.

**ATTENTION: Make sure that all three locating bolts engage at the same time!**  
Pay attention to the clearly audible snap sound of the locking mechanism!

6 /



Befestigung und Fahrzeug dienen als Beispiel. / Fixation and vehicle are examples.

Drücken Sie zum Entriegeln der Seitentasche (1a/1b) einfach den gezeigten Schieber des Verschlussmechanismus nach unten.

To release the side bag (1a/1b) simply press the shown slider of the locking mechanism downward.