

Item number: **KFT.07.976.30000/B**

Revision: **01** · Date: **12 - 2024**

## PRO side carrier

 ~ 1 h.

EASY     DIFFICULT

**ENGLISH** Thank you for choosing this premium product from SW-MOTECH. Visit our online shop for more information (e.g. model assignments). Required documents (e.g. national type approval) are available there for you to download.

**Please read and understand all the instructions, safety information and warnings in these mounting instructions before mounting and using the product in order to avoid injury and damage. Keep these mounting instructions for reference.**

**This product was developed for vehicles in factory condition. Compatibility with original accessories or accessories from other manufacturers cannot be guaranteed.**

**These mounting instructions have been prepared to the best of our current knowledge. No legal claims relating to accuracy can be made. Errors and omissions excepted. We reserve the right to make technical and design changes. The copyright is held by SW-MOTECH.**

### SAFETY WARNING SYMBOL

 This warning symbol is used in these mounting instructions to warn of deadly dangers, injuries or other hazards. The words **DANGER, WARNING or CAUTION** are used as part of this warning symbol to convey important safety messages and information relating to the installation and use of this product. These words, together with the safety warning symbol, mean:

 **DANGER:** Indicates a hazardous situation which, if not avoided, will result in death or serious injury!

 **WARNING:** Indicates a hazardous situation which, if not avoided, may result in death or serious injury!

 **CAUTION:** Indicates a hazardous situation which, if not avoided, may result in minor or moderate injury!

 **NOTE:** Important information, but not relating to a risk of death or injury (property damage only)!

### GENERAL INFORMATION

 **WARNING:** Assembly and/or maintenance of this product requires advanced technical skill, appropriate tools, and a good understanding of tool usage and torque specifications. For your own safety, SW-MOTECH recommends having the assembly and/or maintenance carried out by a qualified and certified motorcycle workshop.

 **WARNING:** If you do choose to assemble this product yourself, carefully and fully read the mounting instructions before assembly and use, and follow all instructions to avoid serious injury or death. Also observe all relevant information in the vehicle manual when mounting or using the product. **IF YOU DO NOT UNDERSTAND ANY PART OF THESE MOUNTING INSTRUCTIONS OR NEED AN EXPLANATION AS TO A SPECIFIC INSTRUCTION, DO NOT ATTEMPT TO INSTALL THIS PRODUCT WITHOUT CONSULTING SW-MOTECH FOR ASSISTANCE!**

**PREPARATION:** Read the mounting instructions carefully and make sure that all parts on the parts list are available.

 **CAUTION:** Ensure that your vehicle is standing securely. Switch off the engine and remove the ignition key. Allow the engine/exhaust to cool down if necessary. Disconnect the battery when working on the electrical system. Only use proper tools and always wear safety goggles and gloves during assembly and maintenance. Have a second person help you with assembly and maintenance.

**ASSEMBLY:** All parts and connections removed from the vehicle must be reinstalled according to the vehicle manufacturer's specifications or replaced with parts and hardware supplied by SW-MOTECH.

 **WARNING:** Secure all threads with a medium-strength liquid threadlocker, unless otherwise specified.

 **DANGER:** Tightening torques not defined by SW-MOTECH must be obtained from the vehicle manufacturer or a certified motorbike workshop.



**FUNCTIONAL CHECK:** After mounting the product, ensure that no moving parts are obstructed and that the function of the vehicle is not impeded. Cables and hoses must not rub against each other and/or be hindered in any way.

 **WARNING:** Carry out a comprehensive functionality check before you start to drive. Check the tightening torque of all connections and the tight fit of the product after the first 50 km and then at regular intervals. Mounted accessories can change the handling and stability of the vehicle.



SW-MOTECH GmbH & Co. KG  
Ernteweg 7-10  
35282 Rauschenberg  
Germany



 [info@sw-motech.com](mailto:info@sw-motech.com)  
 [www.sw-motech.com](http://www.sw-motech.com)

## LEGEND OVERVIEW - READ AND KEEP MOUNTING INSTRUCTIONS!



Take note of the symbols and what they mean in the ASSEMBLY section. If the term OEM appears in the ASSEMBLY section, the vehicle manufacturer's specifications must be observed and applied.



If you have any questions, please don't hesitate to contact our Customer Service team or our distributors. You can find our telephone number and a list of our distributors in our online shop:

**[www.sw-motech.com](http://www.sw-motech.com)**



**Do not use thread lock:** Indicates that no liquid thread lock should be used at this point.







































**Tighten/note the tightening torque information:**

Indicates the tightening torque of a part specified by SW-MOTECH or the vehicle manufacturer (OEM).



**Use thread locker:** Indicates that a thread must be coated with liquid thread locker. H (HIGH): high strength; M (MEDIUM): medium strength; L (LOW): low strength.

PARTS LIST - READ AND KEEP MOUNTING INSTRUCTIONS!





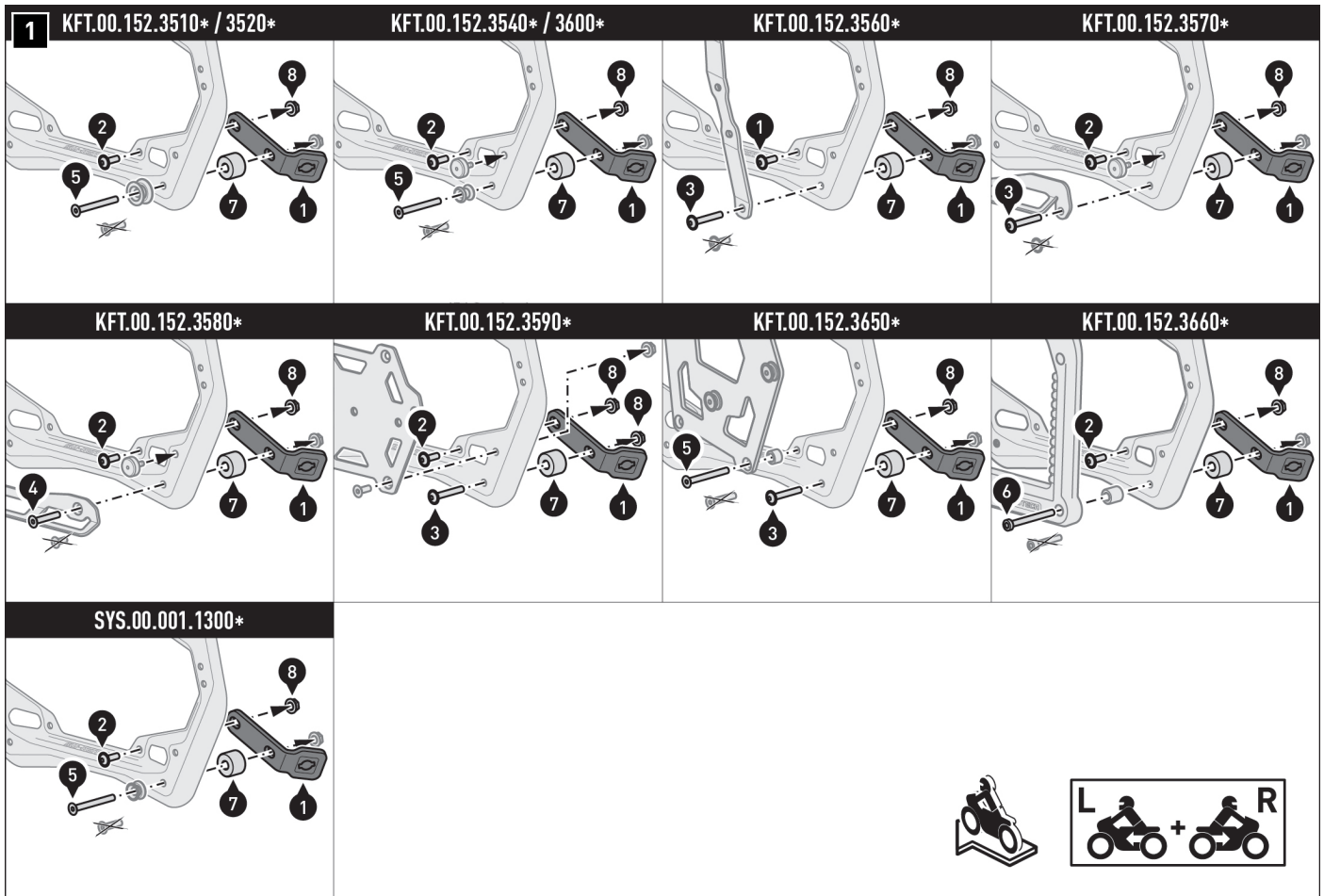









<p><b>1</b></p>  <p>KFT.00.152.028.11</p> <p> 2/2</p>	<p><b>2</b></p>  <p>M6 x 16; ISO 7380 SC.ST.06.016.02.7380.109</p> <p> 2/2</p>	<p><b>3</b></p>  <p>M6 x 35; ISO 7380 SC.ST.06.035.02.7380.109</p> <p> 2/2</p>	<p><b>4</b></p>  <p>M6 x 30; DIN 7991 SC.ST.06.030.02.7991.088</p> <p> 2/2</p>	<p><b>5</b></p>  <p>M6 x 45; DIN 7991 SC.ST.06.045.02.7991.088</p> <p> 2/2</p>	<p><b>6</b></p>  <p>M6 x 50; DIN 6912 SC.ST.06.050.02.6912.088</p> <p> 2/2</p>
<p><b>7</b></p>  <p>Ø 16 / ø 6,4 / h 12 DB.ST.160.064.012.01</p> <p> 2/2</p>	<p><b>8</b></p>  <p>M6; DIN 6927 MU.ST.06.02.6927.08</p> <p> 4/4</p>				
<p><b>7</b></p> <p><b>9</b></p>  <p>KFT.07.976.001.11</p> <p> 2/2</p>	<p><b>10</b></p>  <p>KFT.07.976.002L.11</p> <p> 1/1</p>	<p><b>11</b></p>  <p>KFT.07.976.002R.11</p> <p> 1/1</p>	<p><b>12</b></p>  <p>KFT.07.976.003L.11</p> <p> 1/1</p>	<p><b>13</b></p>  <p>KFT.07.976.003R.11</p> <p> 1/1</p>	<p><b>14</b></p>  <p>M8 x 25; DIN 6912 SC.ST.08.025.02.6912.088</p> <p> 2/2</p>
<p><b>15</b></p>  <p>Ø 8,4; DIN 125 US.ST.084.02.125</p> <p> 6/6</p>					
<p><b>8</b></p> <p><b>16</b></p>  <p>KFT.07.976.971.01.11</p> <p> 1/1</p>	<p><b>17</b></p>  <p>KFT.07.976.972.01.11</p> <p> 1/1</p>	<p><b>18</b></p>  <p>KFT.07.976.004.11</p> <p> 1/1</p>	<p><b>19</b></p>  <p>KFT.00.152.SV.8</p> <p> 1/1</p>		

MOUNTING STEP - READ AND KEEP MOUNTING INSTRUCTIONS!

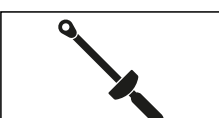

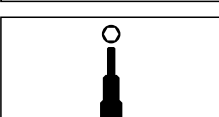
**▲ WARNING: Always wear eye and hand protection!**  
**▲ WARNING: Always use the proper tools!**

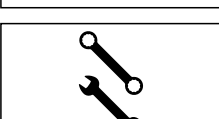
Screw the tabs (1) with the attachment parts assigned for your SW-MOTECH adapter kit to the mounting points shown on the side carriers (15/16). Please follow the mounting instructions for the SW-MOTECH adapter kit. Tighten the screws used (2), (3), (4), (5) and (6) as specified in the mounting instructions.

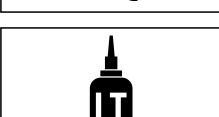
 ×2	 ×4	
 ×2 ⚠ 9.6 Nm		
 ×2 ⚠ 9.6 Nm		
 ×2 ⚠ 9.6 Nm		
 ×2 ⚠ 9.6 Nm		
 ×2 ⚠ 9.6 Nm		
 ×2		

2

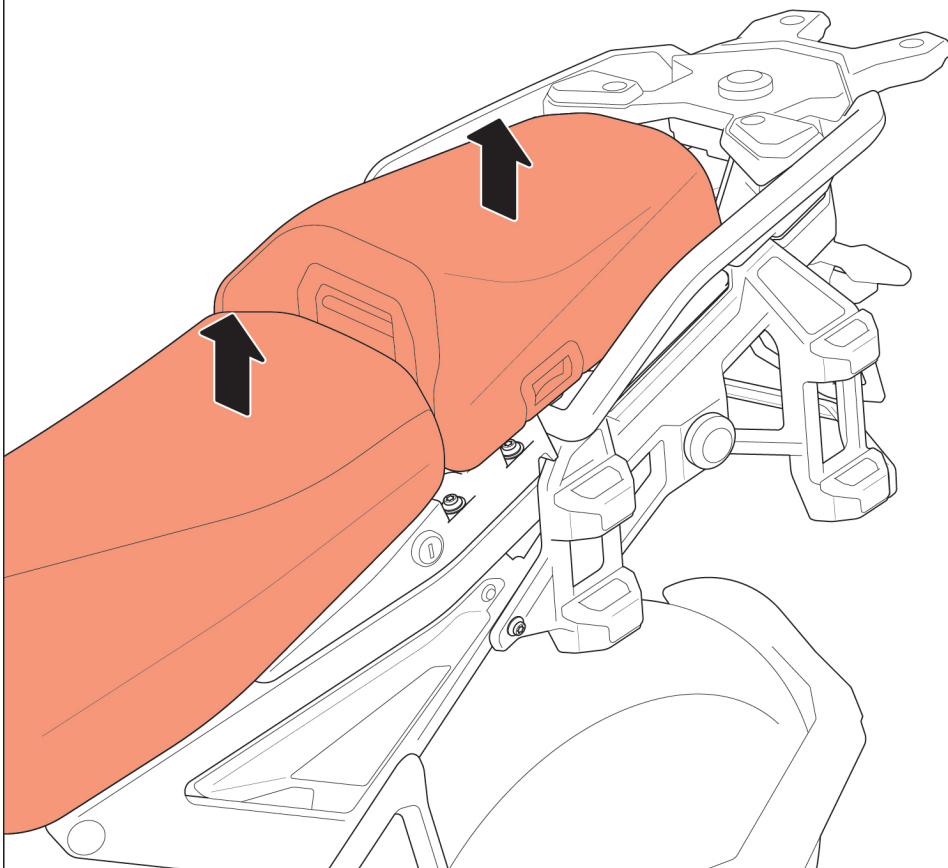

**⚠ NOTE:** If the original side carriers are mounted, they must be removed as described below before mounting the SW-MOTECH carrier.  
If **not**, skip to step 7.

Remove the seat and passenger seat from the vehicle. Depending on how the vehicle is equipped, first disconnect the power supply cables of the seats.

3

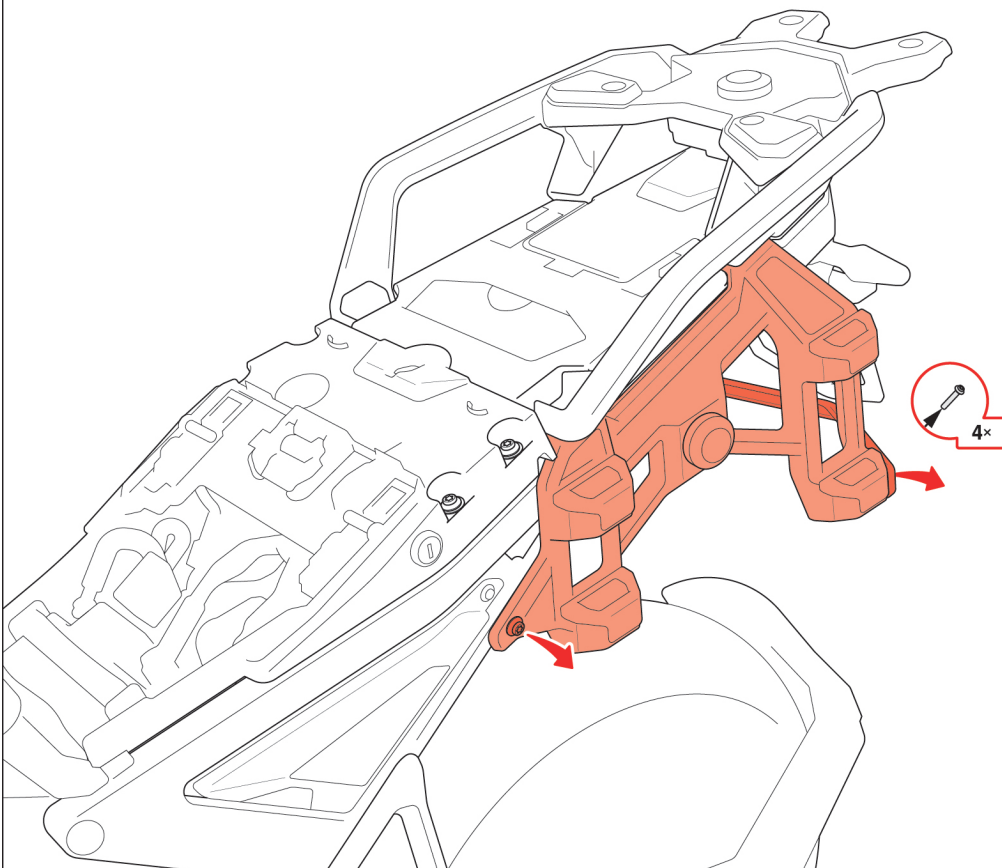

Loosen the marked screws **on both sides** (2x per vehicle side) and remove the crossbar from the vehicle.

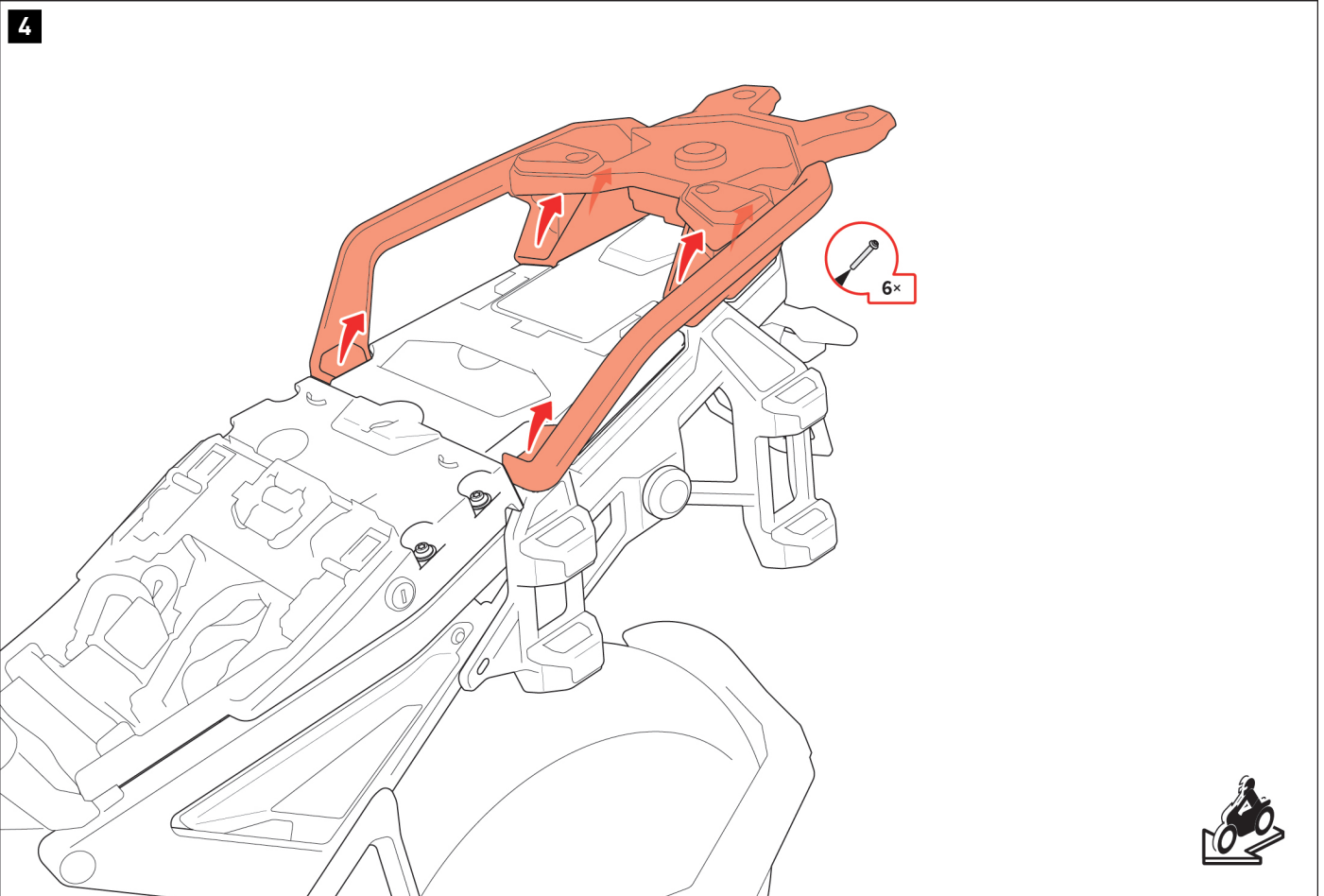

Loosen the marked screws **on both sides** (3x per vehicle side) of the original rack.

5

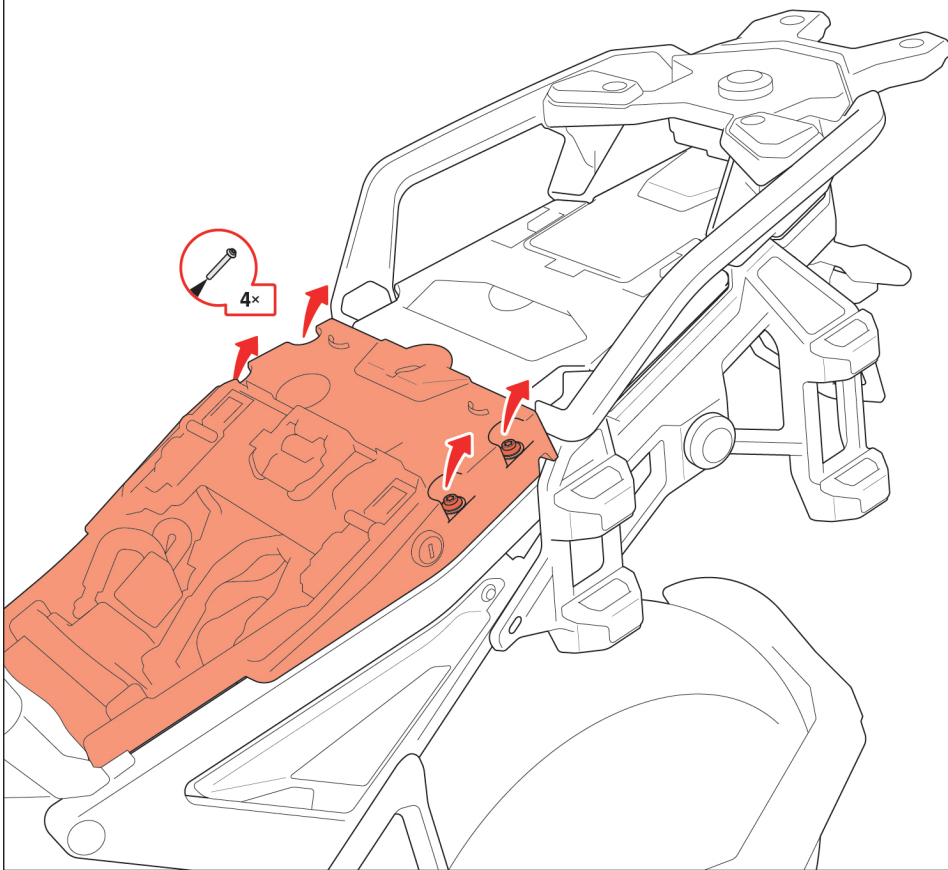

Loosen the marked screws **on both sides** (2x per vehicle side) of the frame cover.



6

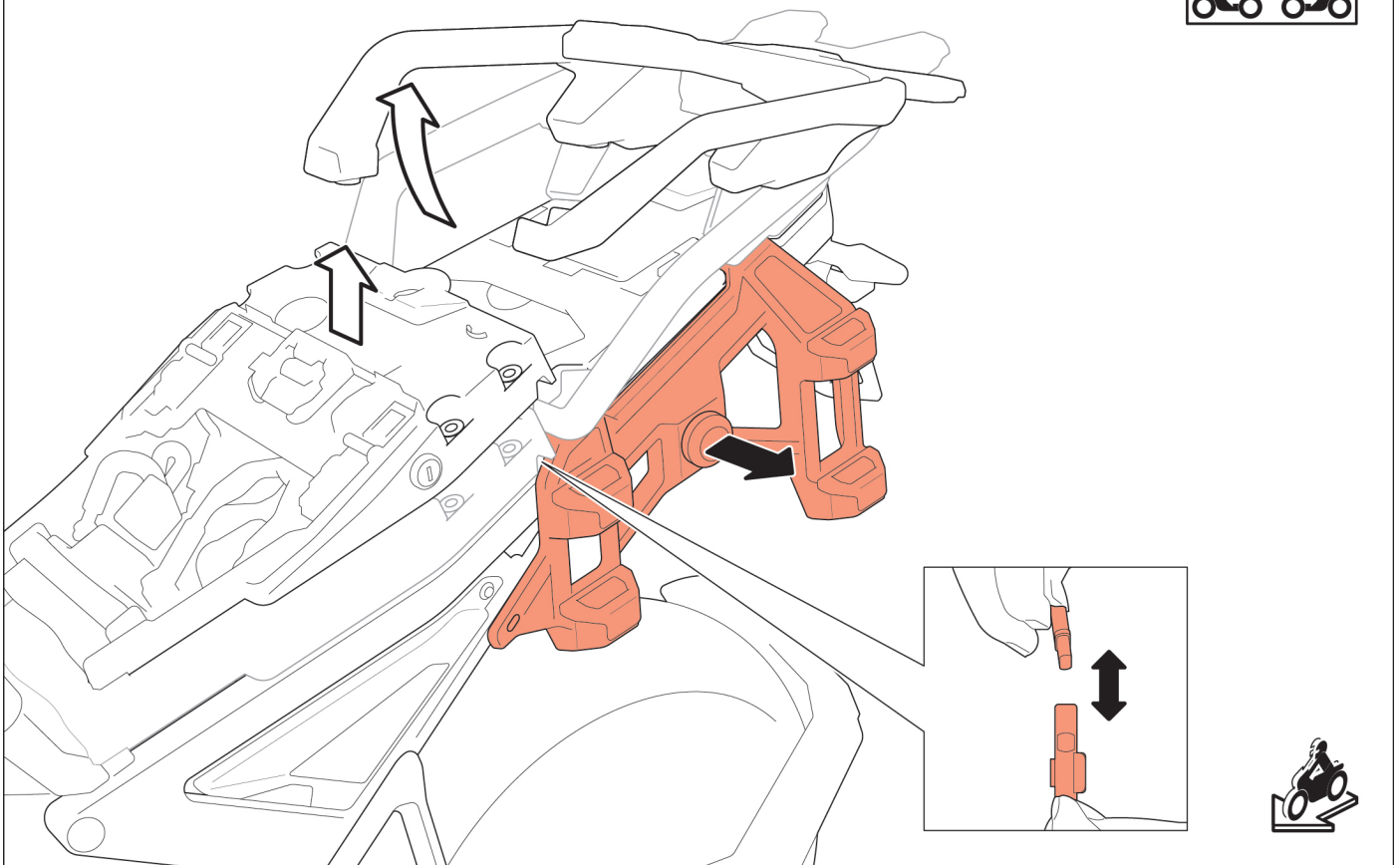

Lift the frame cover and loosen the plugs underneath the original side carriers.

Then lift the original rack and remove the side carriers from the vehicle.

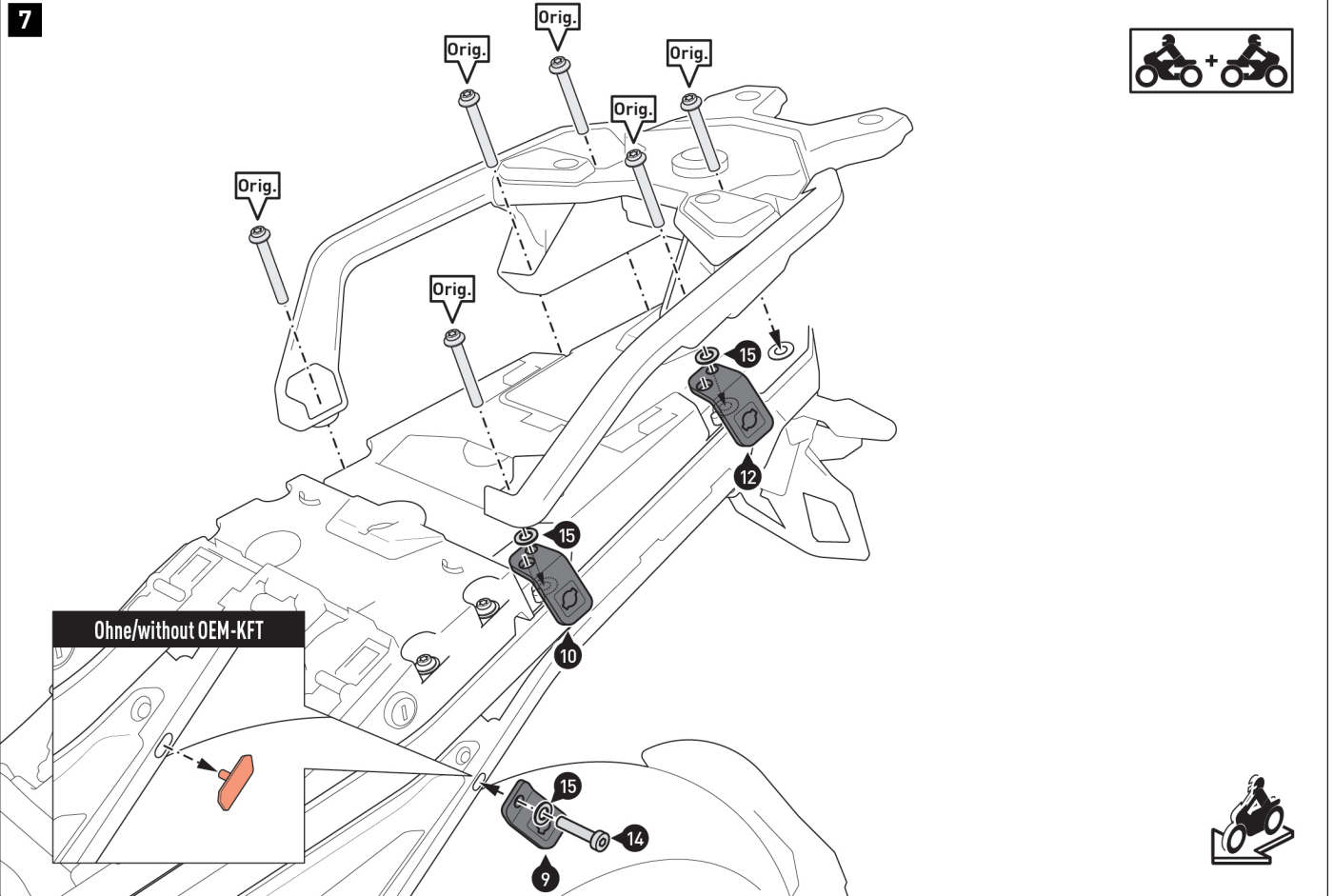

**NOTE:** Pay attention to the hole spacing of the mounting brackets (10/11) and (12/13); the mounting brackets (10/11) with the smaller hole spacing are mounted at the front in the direction of travel, the mounting brackets (12/13) with the larger hole spacing are mounted at the rear in the direction of travel.

**NOTE:** If the original side carriers are **not** mounted, remove the covers shown as specified in the detailed drawing.

Screw the tabs (9), (10/11) and (12/13) **onto both sides** of the vehicle.

**WARNING: Use a liquid threadlocker!**

Do not tighten the screws (14) for the fastening tabs (9) yet. Tighten the original screws (Orig.) the fastening tabs (10/11) and (12/13) according to the vehicle manufacturer's specifications.

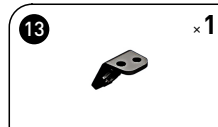
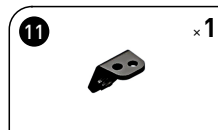
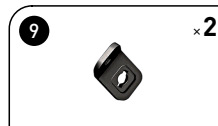

M OEM

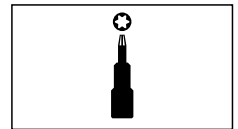
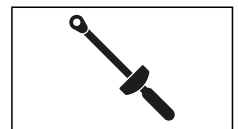

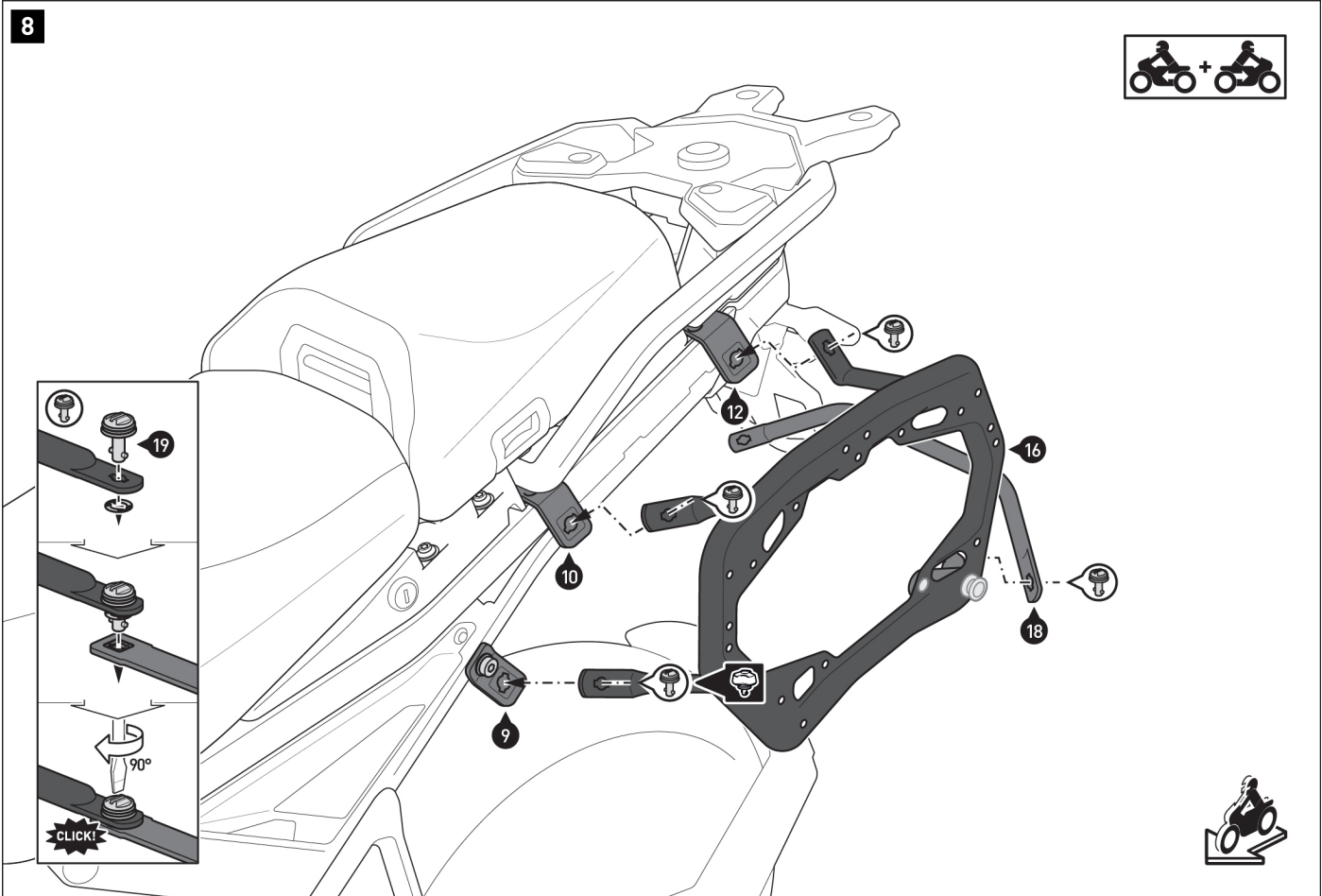

Assemble all parts described in steps [1] to [6] dismantled original parts back on the vehicle in reverse order.

**⚠ NOTE:** The SW-MOTECH anti-theft devices are available separately; mount the anti-theft protection devices on both sides at the indicated position.

Connect the side carriers (16/17) **on both sides** using the quick-release fasteners (19) to the fastening tabs (9), (10/11) and (12/13) as well as to the crossbar (18). Secure the quick-release fasteners using the lock washers.

When all components have been loosely attached, tighten the screws (14) for the fastening tabs (9) according to the vehicle manufacturer's specifications.

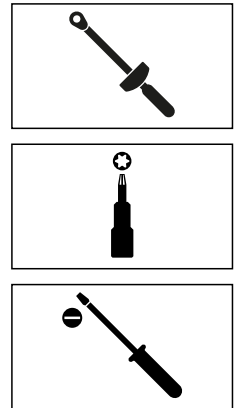
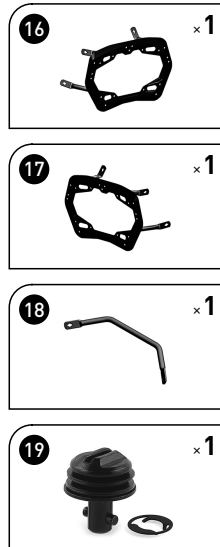

PRODUCT-SPECIFIC NOTES

**⚠ DANGER:** The specified maximum load includes the weight of the carrier adapter kit/luggage and adapter kit! The maximum vehicle load capacity specified by the vehicle manufacturer is applicable!

 ≤ 12.5KG (≤ 27.5 lbs)  ≤ 130 km/h (≤ 80 mph)

**⚠ NOTE:** The side carriers have been designed exclusively for use with SW-MOTECH adapter kits.

**⚠ NOTE:** Dismantle the side carriers when riding without luggage. Always use the side carriers in pairs.

**⚠ WARNING:** Ensure that the cases are NOT in the exhaust gas flow after mounting them on the vehicle! Risk of burns!

**⚠ NOTE:** Ensure you adhere to all country-specific regulations regarding the registration and operation of your vehicle as well as the applicable TÜV (German Association for Technical Inspection) regulations. After assembly, parts that are subject to registration should be entered into the vehicle documents by your test center.