

ANBAUANLEITUNG

mounting instructions • instructions de montage • instrucciones de montaje • istruzioni di montaggio

ADV.07.976.76000

beinhaltet • contains • contient • contiene • contiene

SBL.07.976.10000/B

MSS.07.975.10001/B

MSS.07.975.10200/B

STP.07.176.10002/B

STP.07.176.11001/B

Item number: **SBL.07.976.10000/B**

Revision: **00** · Date: **11 - 2024**

Upper crash bar

 ~ 1.5 h.

EASY      DIFFICULT

ENGLISH Thank you for choosing this premium product from SW-MOTECH. Visit our online shop for more information (e.g. model assignments). Required documents (e.g. national type approval) are available there for you to download.

Please read and understand all the instructions, safety information and warnings in these mounting instructions before mounting and using the product in order to avoid injury and damage. Keep these mounting instructions for reference.

This product was developed for vehicles in factory condition. Compatibility with original accessories or accessories from other manufacturers cannot be guaranteed.

These mounting instructions have been prepared to the best of our current knowledge. No legal claims relating to accuracy can be made. Errors and omissions excepted. We reserve the right to make technical and design changes. The copyright is held by SW-MOTECH.

SAFETY WARNING SYMBOL

 This warning symbol is used in these mounting instructions to warn of deadly dangers, injuries or other hazards. The words **DANGER**, **WARNING** or **CAUTION** are used as part of this warning symbol to convey important safety messages and information relating to the installation and use of this product. These words, together with the safety warning symbol, mean:

 **DANGER:** Indicates a hazardous situation which, if not avoided, will result in death or serious injury!

 **WARNING:** Indicates a hazardous situation which, if not avoided, may result in death or serious injury!

 **CAUTION:** Indicates a hazardous situation which, if not avoided, may result in minor or moderate injury!

 **NOTE:** Important information, but not relating to a risk of death or injury (property damage only)!

GENERAL INFORMATION

 **WARNING:** Assembly and/or maintenance of this product requires advanced technical skill, appropriate tools, and a good understanding of tool usage and torque specifications. For your own safety, SW-MOTECH recommends having the assembly and/or maintenance carried out by a qualified and certified motorcycle workshop.

 **WARNING:** If you do choose to assemble this product yourself, carefully and fully read the mounting instructions before assembly and use, and follow all instructions to avoid serious injury or death. Also observe all relevant information in the vehicle manual when mounting or using the product. IF YOU DO NOT UNDERSTAND ANY PART OF THESE MOUNTING INSTRUCTIONS OR NEED AN EXPLANATION AS TO A SPECIFIC INSTRUCTION, DO NOT ATTEMPT TO INSTALL THIS PRODUCT WITHOUT CONSULTING SW-MOTECH FOR ASSISTANCE!

PREPARATION: Read the mounting instructions carefully and make sure that all parts on the parts list are available.

 **CAUTION:** Ensure that your vehicle is standing securely. Switch off the engine and remove the ignition key. Allow the engine/exhaust to cool down if necessary. Disconnect the battery when working on the electrical system. Only use proper tools and always wear safety goggles and gloves during assembly and maintenance. Have a second person help you with assembly and maintenance.

ASSEMBLY: All parts and connections removed from the vehicle must be reinstalled according to the vehicle manufacturer's specifications or replaced with parts and hardware supplied by SW-MOTECH.

 **WARNING:** Secure all threads with a medium-strength liquid threadlocker, unless otherwise specified.

 **DANGER:** Tightening torques not defined by SW-MOTECH must be obtained from the vehicle manufacturer or a certified motorbike workshop.

FUNCTIONAL CHECK: After mounting the product, ensure that no moving parts are obstructed and that the function of the vehicle is not impeded. Cables and hoses must not rub against each other and/or be hindered in any way.

 **WARNING:** Carry out a comprehensive functionality check before you start to drive. Check the tightening torque of all connections and the tight fit of the product after the first 50 km and then at regular intervals. Mounted accessories can change the handling and stability of the vehicle.



SW-MOTECH GmbH & Co. KG
Ernteweg 7-10
35282 Rauschenberg
Germany



 info@sw-motech.com
 www.sw-motech.com



Take note of the symbols and what they mean in the ASSEMBLY section. If the term OEM appears in the ASSEMBLY section, the vehicle manufacturer's specifications must be observed and applied.



If you have any questions, please don't hesitate to contact our Customer Service team or our distributors. You can find our telephone number and a list of our distributors in our online shop:

www.sw-motech.com



Use thread locker: Indicates that a thread must be coated with liquid thread locker. H (HIGH): high strength; M (MEDIUM): medium strength; L (LOW): low strength.



Tighten/note the tightening torque information:

Indicates the tightening torque of a part specified by SW-MOTECH or the vehicle manufacturer (OEM).



Do not use thread lock: Indicates that no liquid thread lock should be used at this point.

PARTS LIST - READ AND KEEP MOUNTING INSTRUCTIONS!

10

1



SBL.07.976.001L.11

1/1

2



SBL.07.976.001R.11

1/1

3



M5 x 20; ISO 7380
SC.ST.05.020.02.7380.109

4/4

11

4



SBL.07.976.901.01.11

1/1

5



SBL.07.976.902.01.11

1/1

6



M8 x 120; DIN 912
SC.ST.08.120.01.912.109

2/2

7



ø 8,4; DIN 9021
US.ST.084.02.9021

2/2

8



Ø 25 / ø 8,4 / h 62
DB.ST.0250.0084.0620.02

2/2

9



M8 x 25; DIN 933
SC.ST.08.025.01.933.088

2/2

10



ø 8,4; DIN 125
US.ST.084.01.125

2/2

11



M8; DIN 6927
MU.ST.08.01.6927.08

2/2

12



M6 x 16; DIN 912
SC.ST.06.016.02.912.088

2/2

13



M6; DIN 985
MU.ST.06.01.985.08

2/2

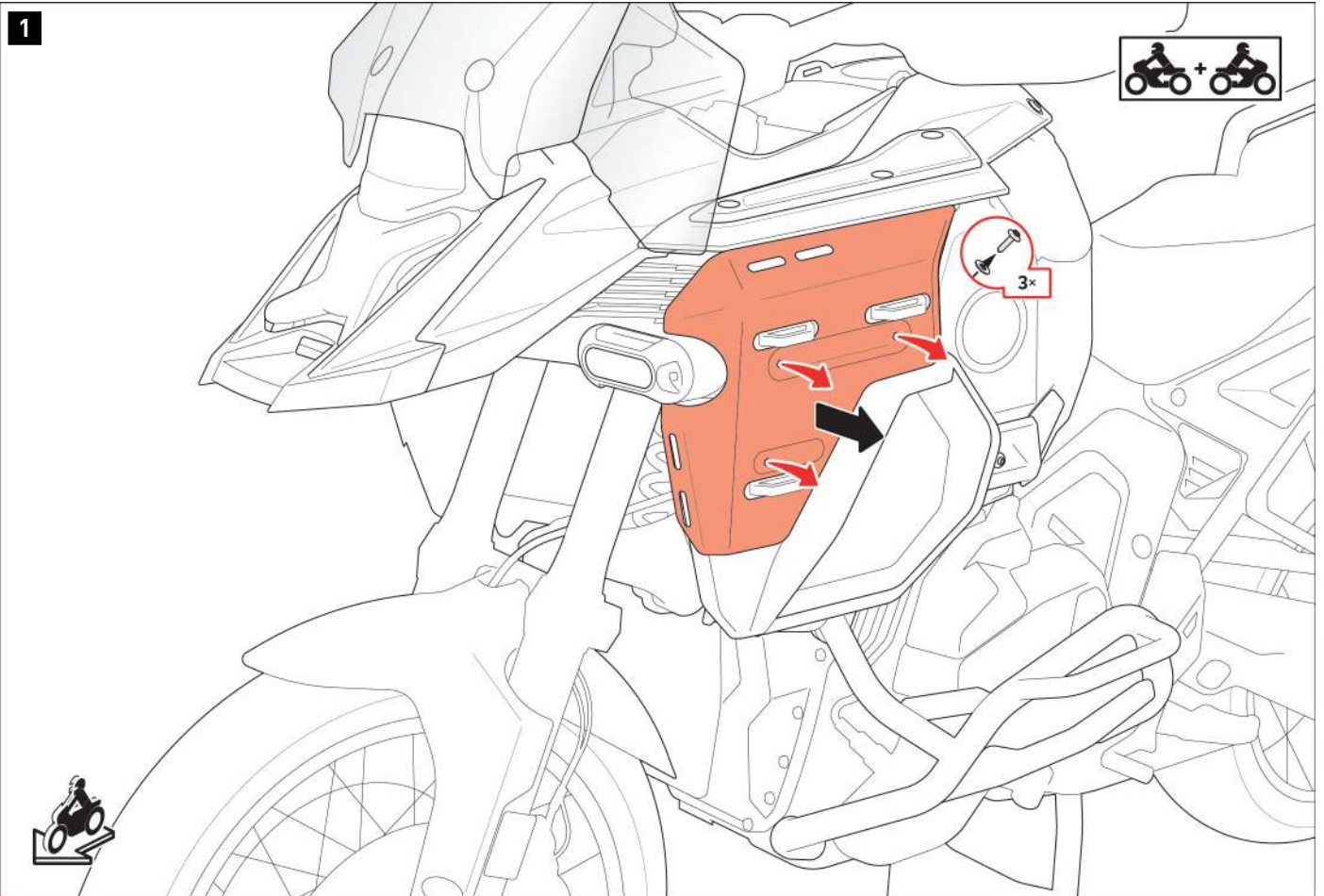

⚠ WARNING: Always wear eye and hand protection!
⚠ WARNING: Always use the proper tools!

⚠ WARNING: Have a second person help you!

⚠ NOTE: Disassembly / assembly shown is for the **left side** of the vehicle. Repeat the steps in the same way for the right side of the vehicle.

⚠ WARNING: Installing this product is complicated! We recommend that it is installed by a qualified and certified specialist workshop!

Loosen the marked screws **on both sides** (3x per vehicle side) and remove the fairings from the vehicle.



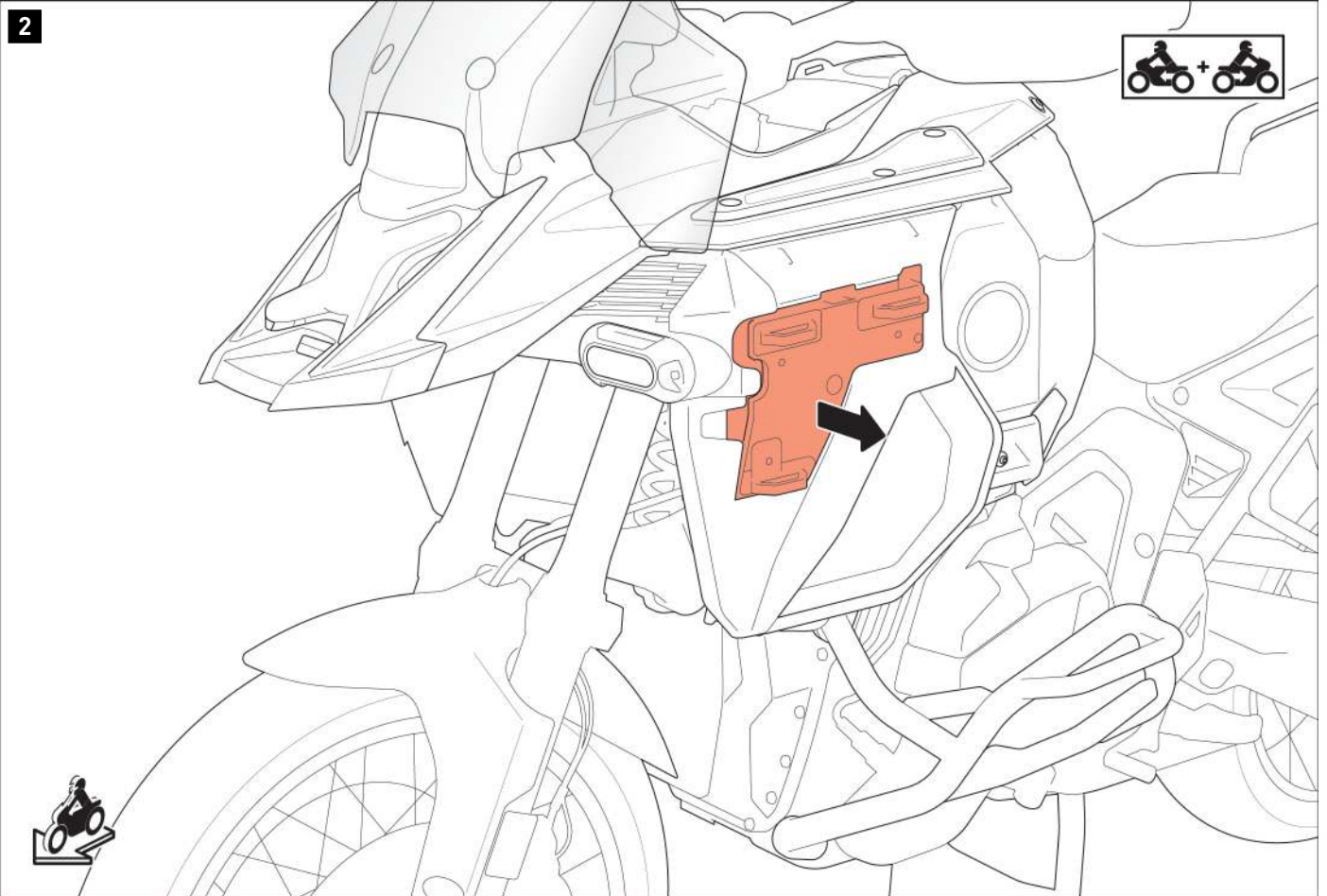

Remove the inner fairings from **both sides** of the vehicle.

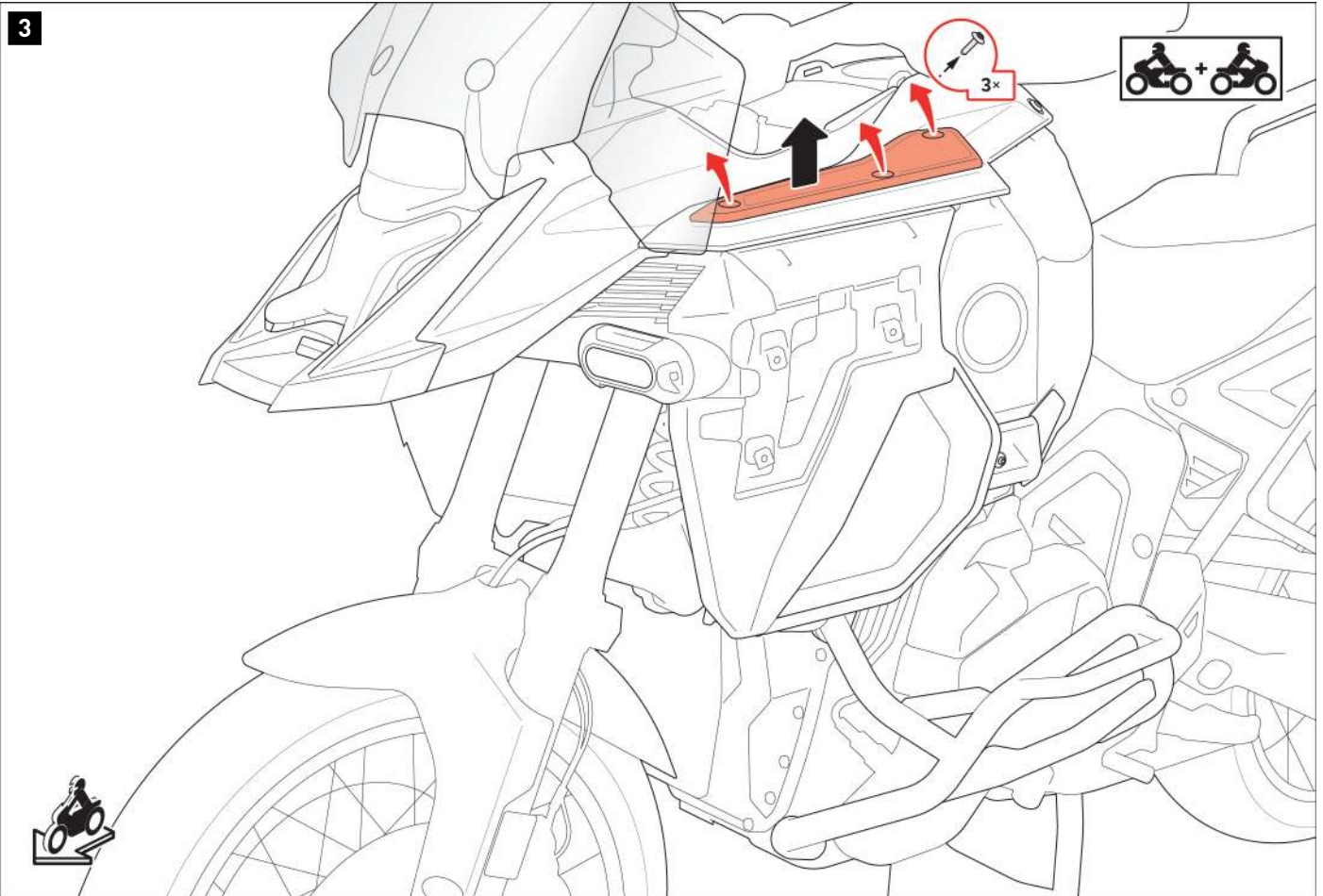

Loosen the marked screws **on both sides** (3x per vehicle side) and remove the fairings from the vehicle.

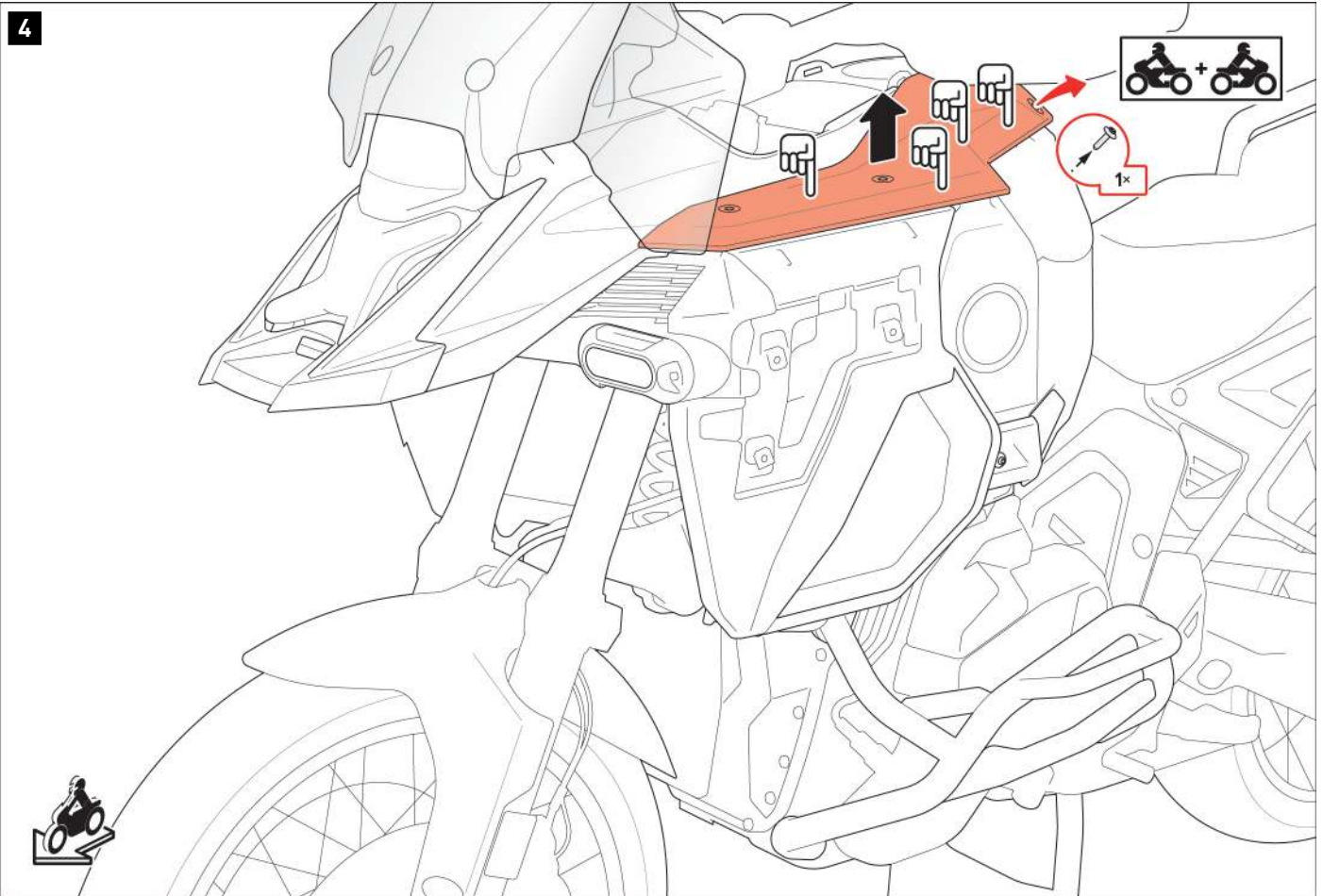

Loosen the marked screws **on both sides** (1x per vehicle side) and remove the fairings from the vehicle.

⚠ NOTE: Pay attention to the marked plug anchors on the fairings.

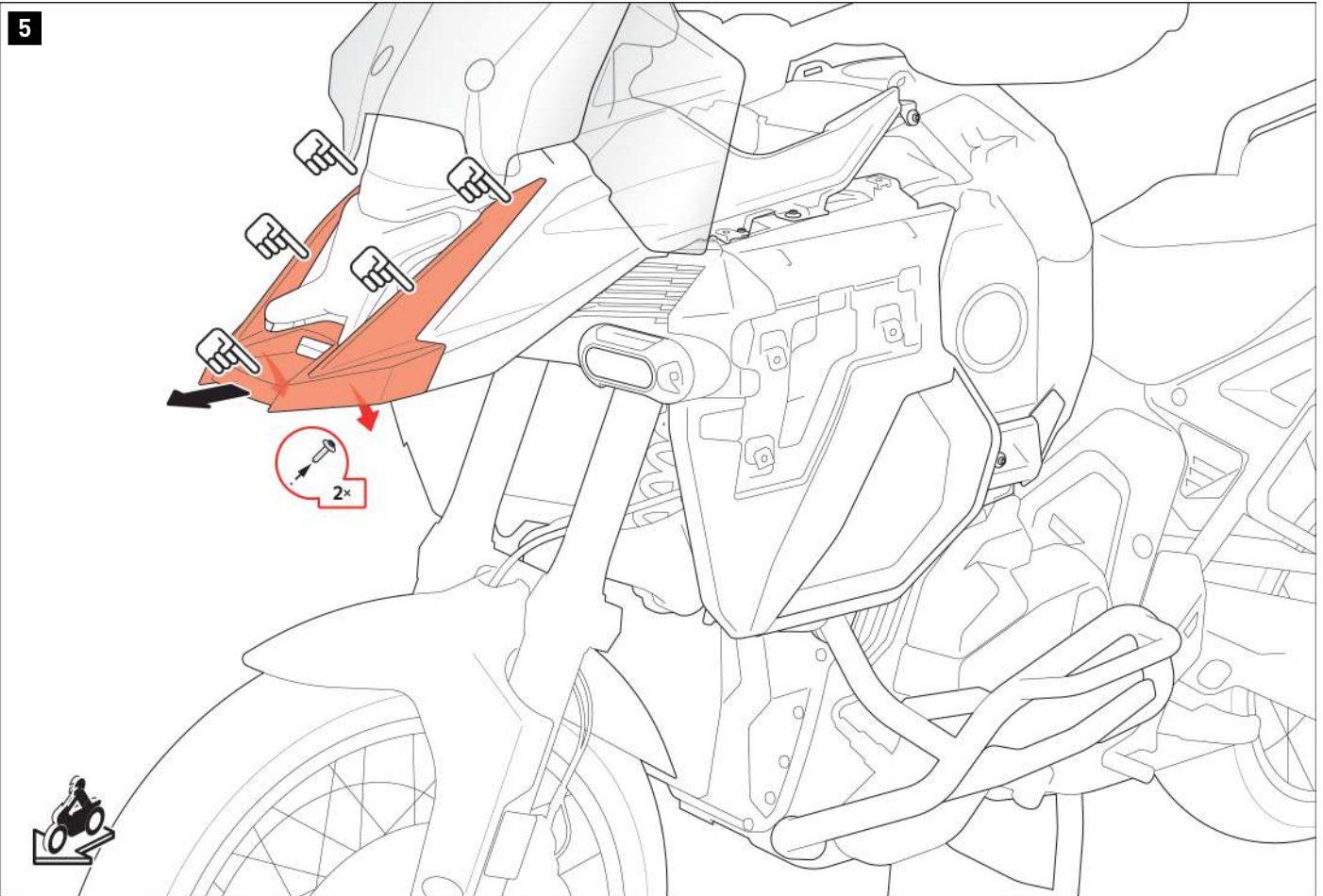

Loosen the marked screws (2x) and remove the fairing from the vehicle.
⚠ NOTE: Pay attention to the marked plug anchors on the fairing.

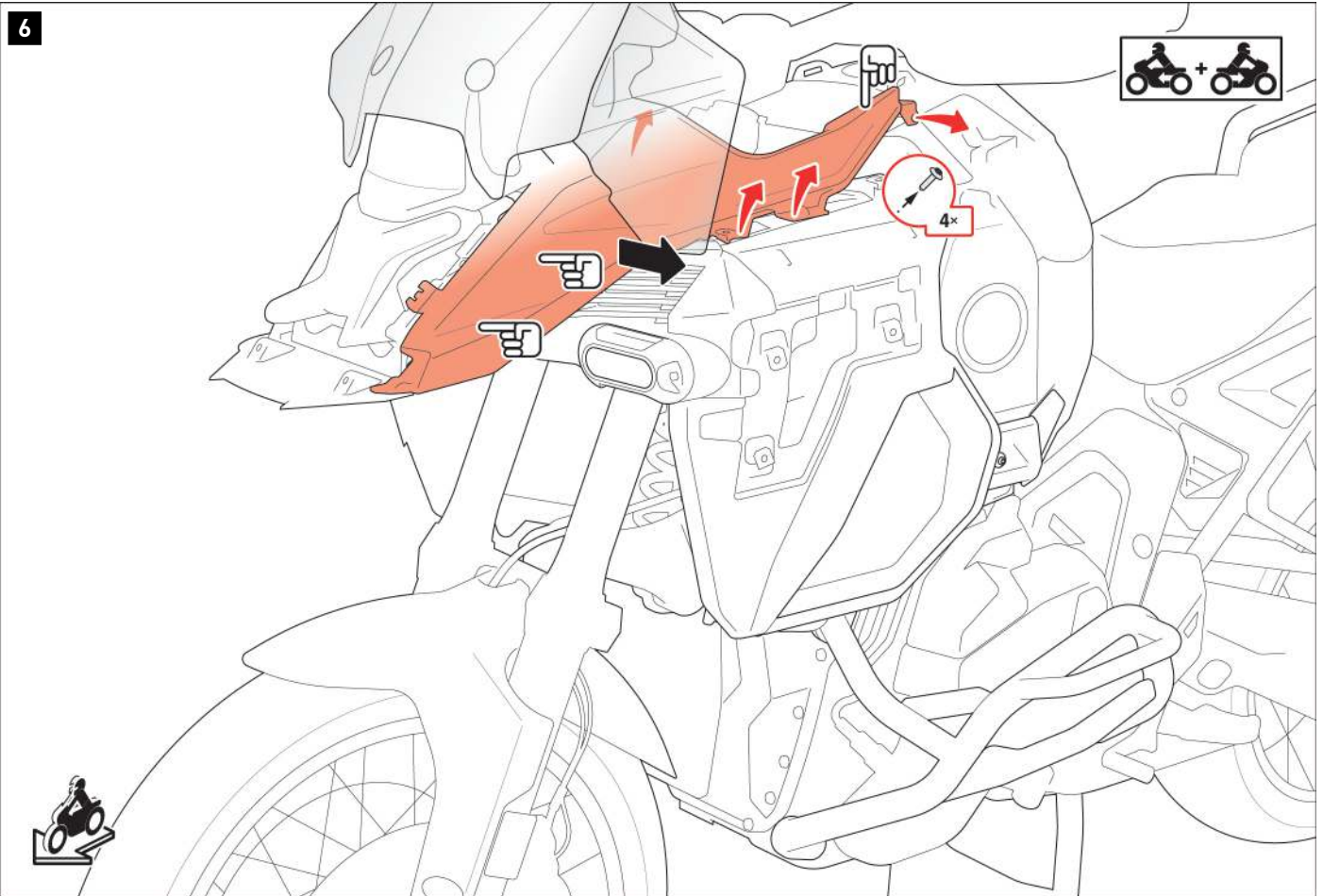

Loosen the marked screws **on both sides** (4x per vehicle side) and remove the fairing from the vehicle.

⚠ NOTE: Pay attention to the marked plug anchors on the fairings.

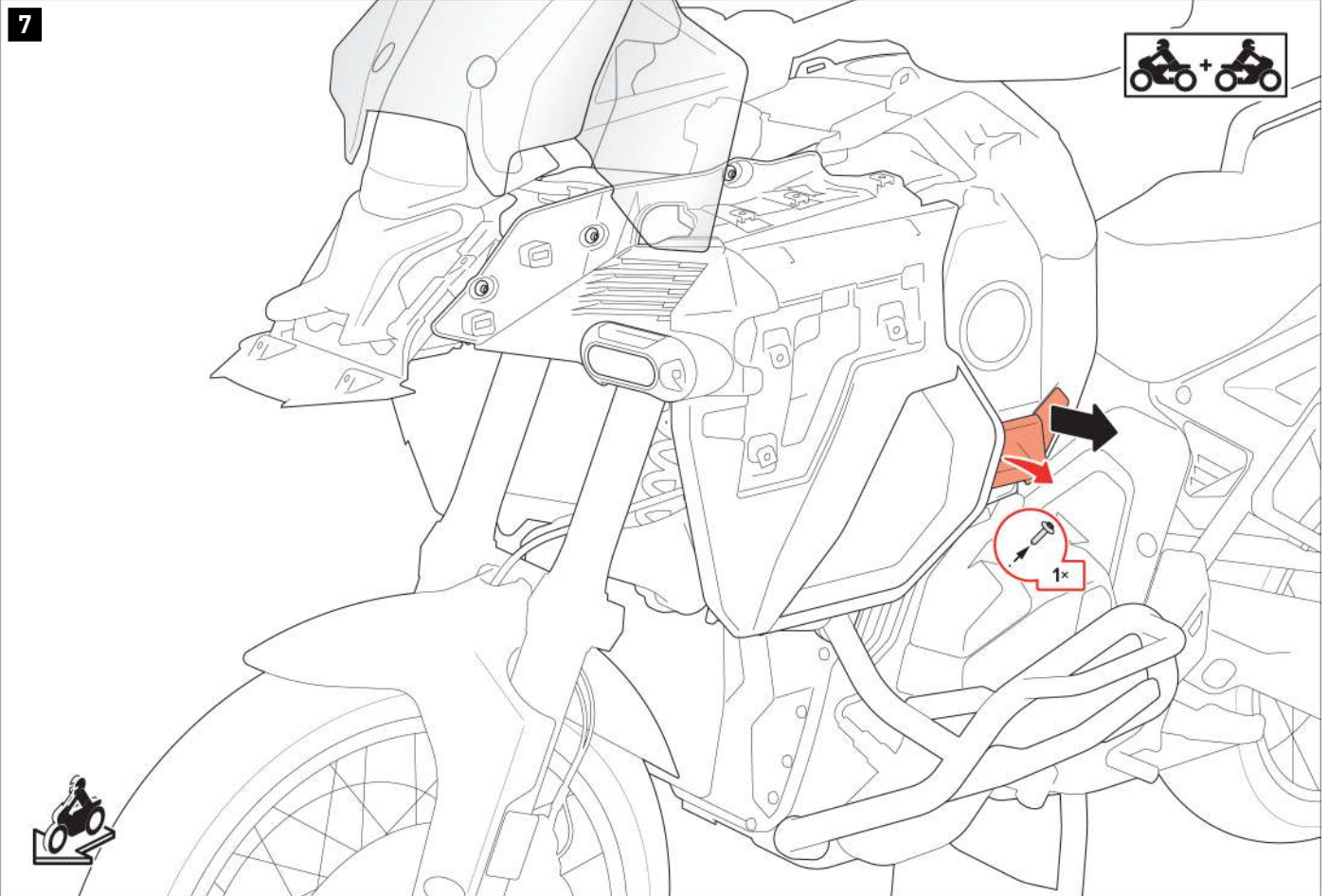

Loosen the marked screws **on both sides** (1x per vehicle side) and remove the fairings from the vehicle.

⚠ NOTE: The fairings are secured by two plug connections.

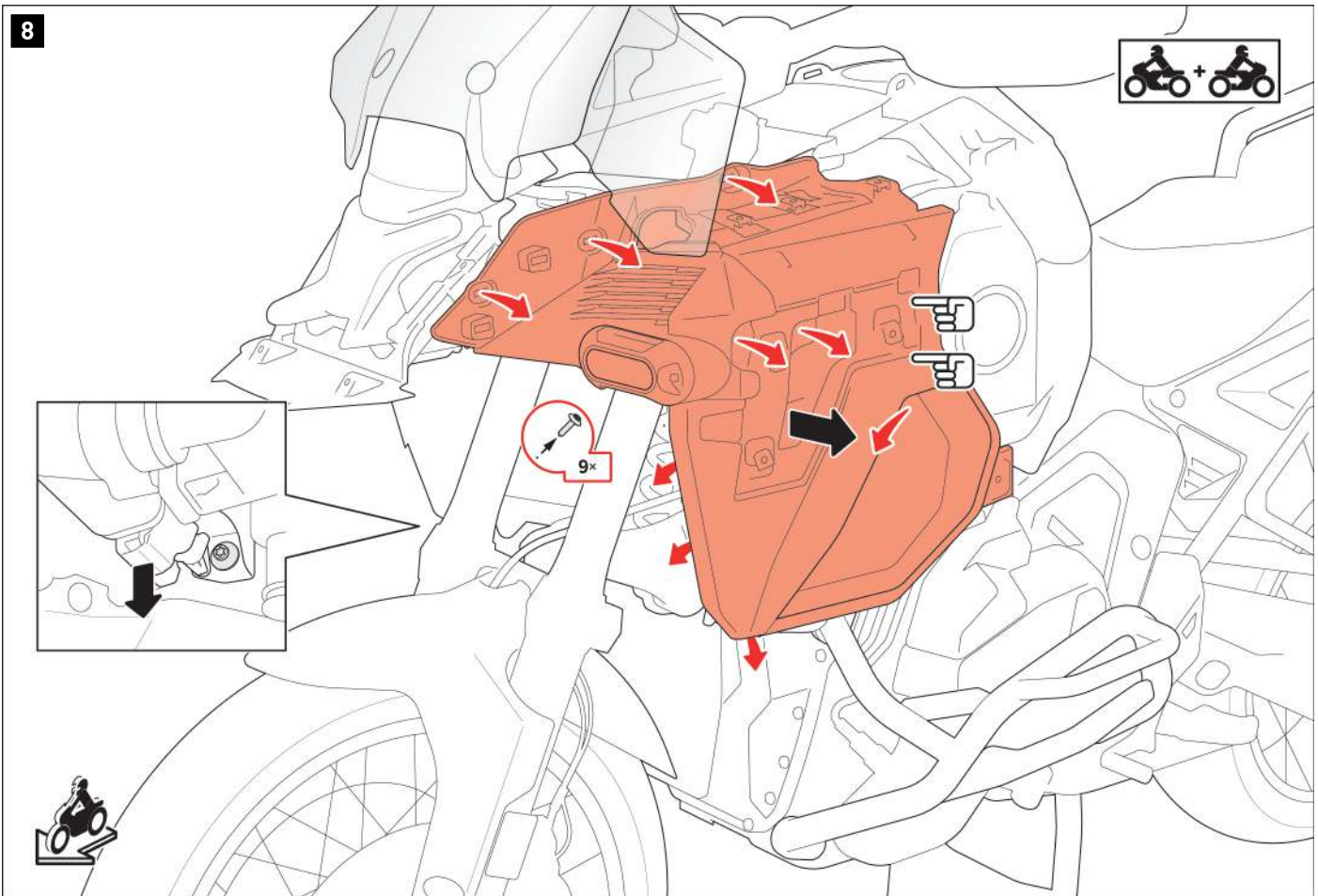

⚠ **NOTE:** On the **right** side of the vehicle, the plug shown in the detailed drawing must first be pulled out of its anchorage.

⚠ **NOTE:** Complete disassembly of the fairings is shown in the interest of clarity only. The headlight wiring does not need to be disconnected.

Loosen the marked screws **on both sides** (9x per vehicle side) and remove the fairings from the vehicle.

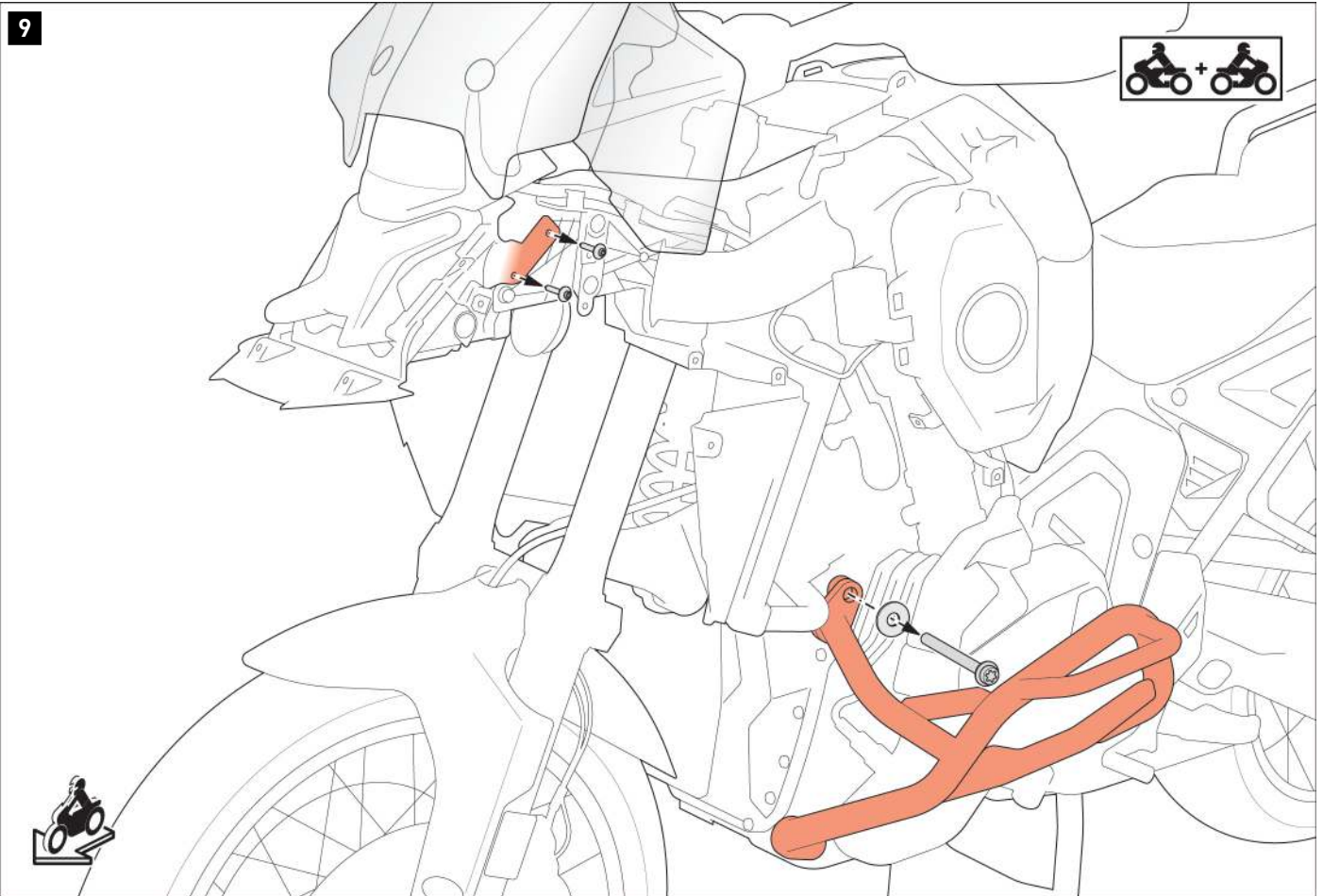

Remove the marked screws from the mounting points on **both** sides.
⚠ NOTE: Make sure that the internal spacers on the original crash bar stay in place.

10

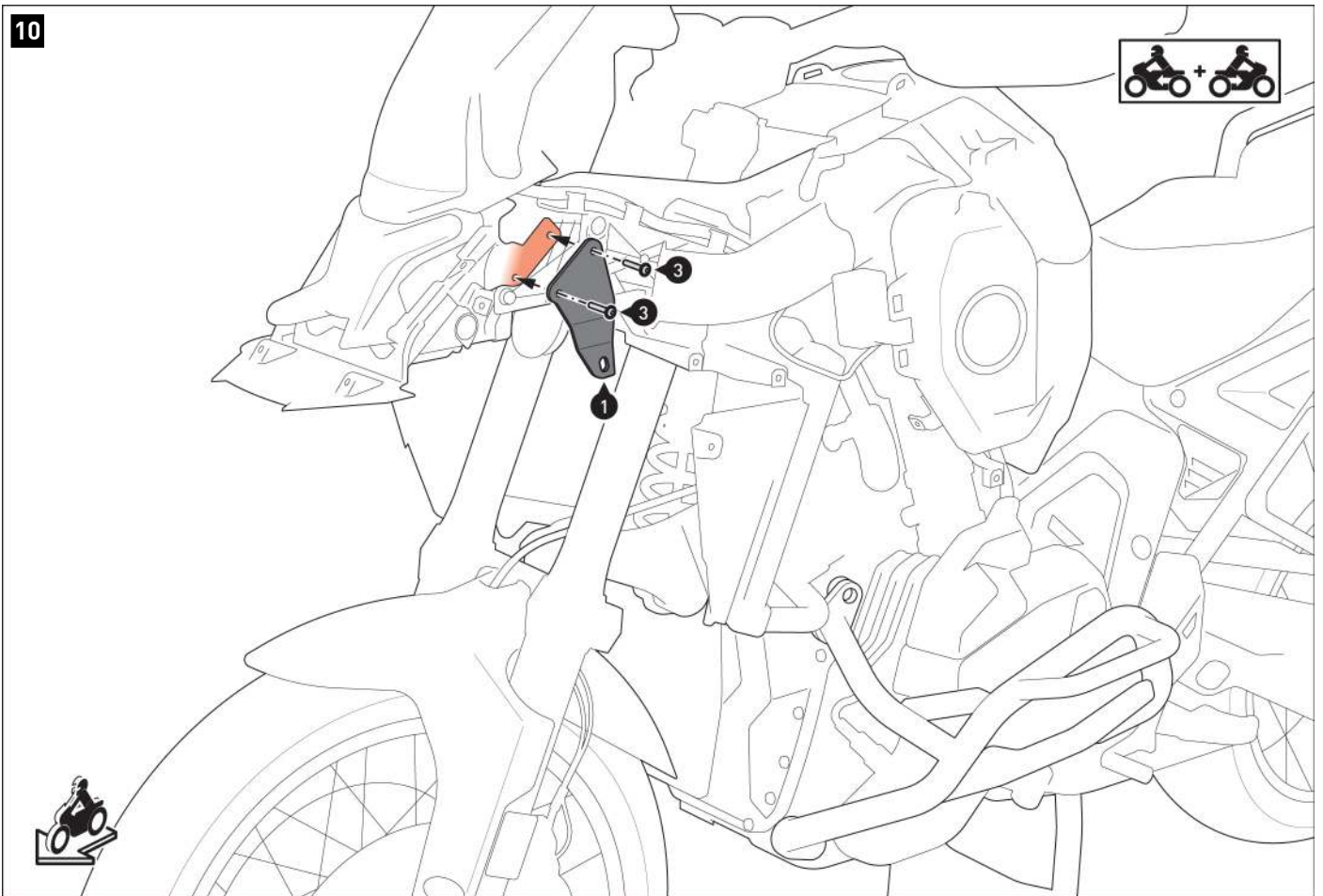

Screw the mounting brackets [1/2] onto both sides of the vehicle.
▲ WARNING: Use a liquid threadlocker!
 Tighten the screws [3] according to the vehicle manufacturer's specifications.

Then reinstall all the fairings removed in steps [1] to [8] in reverse order.
 Tighten all original screws according to the vehicle manufacturer's specifications.
 Then push the plug you loosened in step [8] back into its anchorage.

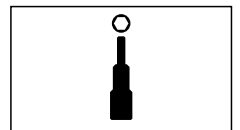
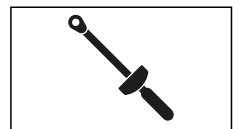

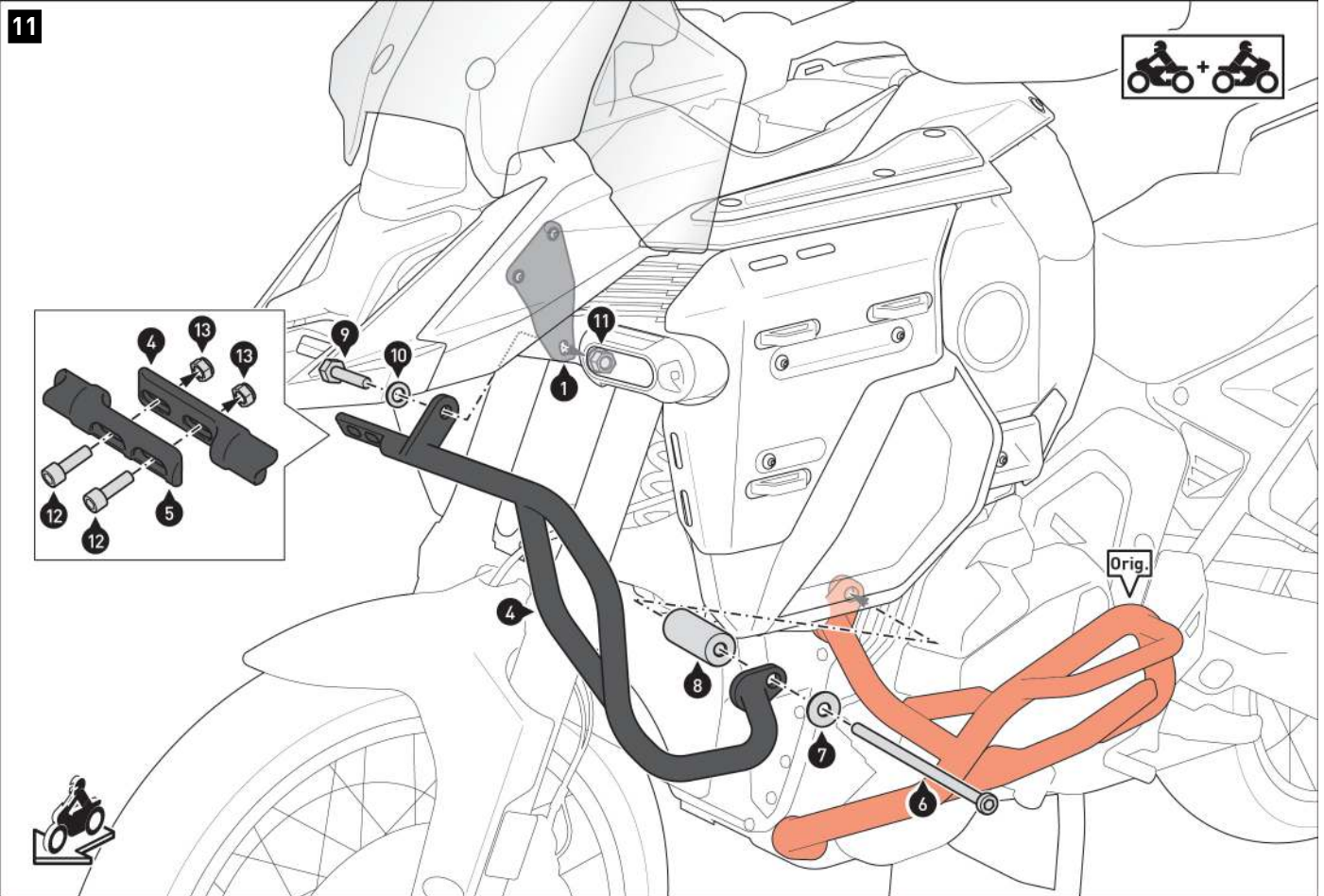

Screw the crash bar halves (4/5) **on both sides** to the mounting brackets (1/2) and the original crash bars (Orig.).

▲ WARNING: Use liquid thread locker (screws (6) only)!
Do not tighten screws (6) and (9) yet.

Then screw the two crash bar halves (4/5) together at the front connecting pieces, as shown in the detailed drawing. Do not tighten the screws (12) yet.

When all components have been loosely attached, tighten the screws (6) according to the vehicle manufacturer's specifications. Then tighten the screws (9) and (12) as described in the mounting instructions.

▲ WARNING: Finally, carry out a functional check of the headlights!

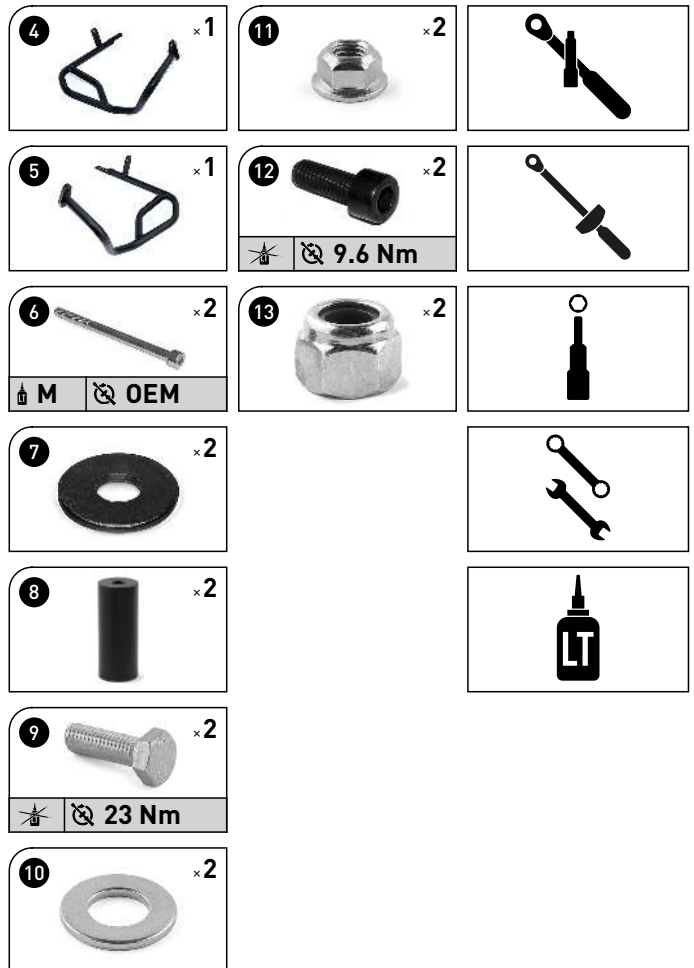

PRODUCT-SPECIFIC NOTES

⚠ WARNING: This product may inhibit cornering and ground clearance in cases of extreme inclination!

⚠ NOTE: Please observe the country-specific regulations for the registration/operation of your vehicle or any applicable TÜV regulations. After installation, parts subject to registration should be entered in the vehicle documents by your test center.

Item number: **MSS.07.975.10001/B**

Revision: **00** · Date: **01 - 2025**

Engine guard

 ~ 1 h.

EASY     DIFFICULT

ENGLISH Thank you for choosing this premium product from SW-MOTECH. Visit our online shop for more information (e.g. model assignments). Required documents (e.g. national type approval) are available there for you to download.

Please read and understand all the instructions, safety information and warnings in these mounting instructions before mounting and using the product in order to avoid injury and damage. Keep these mounting instructions for reference.

This product was developed for vehicles in factory condition. Compatibility with original accessories or accessories from other manufacturers cannot be guaranteed.

These mounting instructions have been prepared to the best of our current knowledge. No legal claims relating to accuracy can be made. Errors and omissions excepted. We reserve the right to make technical and design changes. The copyright is held by SW-MOTECH.

SAFETY WARNING SYMBOL

 This warning symbol is used in these mounting instructions to warn of deadly dangers, injuries or other hazards. The words **DANGER**, **WARNING** or **CAUTION** are used as part of this warning symbol to convey important safety messages and information relating to the installation and use of this product. These words, together with the safety warning symbol, mean:

 **DANGER:** Indicates a hazardous situation which, if not avoided, will result in death or serious injury!

 **WARNING:** Indicates a hazardous situation which, if not avoided, may result in death or serious injury!

 **CAUTION:** Indicates a hazardous situation which, if not avoided, may result in minor or moderate injury!

 **NOTE:** Important information, but not relating to a risk of death or injury (property damage only)!

GENERAL INFORMATION

 **WARNING:** Assembly and/or maintenance of this product requires advanced technical skill, appropriate tools, and a good understanding of tool usage and torque specifications. For your own safety, SW-MOTECH recommends having the assembly and/or maintenance carried out by a qualified and certified motorcycle workshop.

 **WARNING:** If you do choose to assemble this product yourself, carefully and fully read the mounting instructions before assembly and use, and follow all instructions to avoid serious injury or death. Also observe all relevant information in the vehicle manual when mounting or using the product. **IF YOU DO NOT UNDERSTAND ANY PART OF THESE MOUNTING INSTRUCTIONS OR NEED AN EXPLANATION AS TO A SPECIFIC INSTRUCTION, DO NOT ATTEMPT TO INSTALL THIS PRODUCT WITHOUT CONSULTING SW-MOTECH FOR ASSISTANCE!**

PREPARATION: Read the mounting instructions carefully and make sure that all parts on the parts list are available.

 **CAUTION:** Ensure that your vehicle is standing securely. Switch off the engine and remove the ignition key. Allow the engine/exhaust to cool down if necessary. Disconnect the battery when working on the electrical system. Only use proper tools and always wear safety goggles and gloves during assembly and maintenance. Have a second person help you with assembly and maintenance.

ASSEMBLY: All parts and connections removed from the vehicle must be reinstalled according to the vehicle manufacturer's specifications or replaced with parts and hardware supplied by SW-MOTECH.

 **WARNING:** Secure all threads with a medium-strength liquid threadlocker, unless otherwise specified.

 **DANGER:** Tightening torques not defined by SW-MOTECH must be obtained from the vehicle manufacturer or a certified motorbike workshop.



FUNCTIONAL CHECK: After mounting the product, ensure that no moving parts are obstructed and that the function of the vehicle is not impeded. Cables and hoses must not rub against each other and/or be hindered in any way.

 **WARNING:** Carry out a comprehensive functionality check before you start to drive. Check the tightening torque of all connections and the tight fit of the product after the first 50 km and then at regular intervals. Mounted accessories can change the handling and stability of the vehicle.



SW-MOTECH GmbH & Co. KG
Ernteweg 7-10
35282 Rauschenberg
Germany



 info@sw-motech.com
 www.sw-motech.com



Take note of the symbols and what they mean in the ASSEMBLY section. If the term OEM appears in the ASSEMBLY section, the vehicle manufacturer's specifications must be observed and applied.



If you have any questions, please don't hesitate to contact our Customer Service team or our distributors. You can find our telephone number and a list of our distributors in our online shop:

www.sw-motech.com



Use thread locker: Indicates that a thread must be coated with liquid thread locker. H (HIGH): high strength; M (MEDIUM): medium strength; L (LOW): low strength.































Tighten/note the tightening torque information: Indicates the tightening torque of a part specified by SW-MOTECH or the vehicle manufacturer (OEM).



Do not use thread lock: Indicates that no liquid thread lock should be used at this point.

PARTS LIST - READ AND KEEP MOUNTING INSTRUCTIONS!

<p>3</p> <p>1</p>  <p>MSS.07.975.002.11</p> <p> 1/1</p>	<p>2</p>  <p>MSS.07.975.003.11</p> <p> 1/1</p>	<p>3</p>  <p>MSS.07.975.004.11</p> <p> 1/1</p>	<p>4</p>  <p>M8 x 16; DIN 933 SC.ST.08.016.02.933.088</p> <p> 2/8</p>	<p>5</p>  <p>M8 x 25; DIN 912 SC.ST.08.025.46.912.109</p> <p> 2/2</p>	<p>6</p>  <p>M8 x 30; ISO 7380 SC.ST.08.030.02.7380.109</p> <p> 1/1</p>
<p>7</p>  <p>M8 x 25; ISO 7380 SC.ST.08.025.02.7380.109</p> <p> 1/1</p>	<p>8</p>  <p>Ø 20 / ø 8,4 / h 5 DB.ST.200.084.005.01</p> <p> 1/1</p>	<p>9</p>  <p>M8; DIN 6927 MU.ST.08.02.6927.08</p> <p> 2/2</p>	<p>10</p>  <p>ø 8,4; DIN 125 US.ST.084.02.125</p> <p> 4/10</p>	<p>11</p>  <p>KB.PA.025.098.02</p> <p> 1/1</p>	
<p>4</p> <p>12</p>  <p>MSS.07.975.900.02.02</p> <p> 1/1</p>	<p>13</p>  <p>M8 x 16; DIN 933 SC.ST.08.016.02.933.088</p> <p> 6/8</p>	<p>14</p>  <p>ø 8,4; DIN 125 US.ST.084.02.125</p> <p> 6/10</p>			

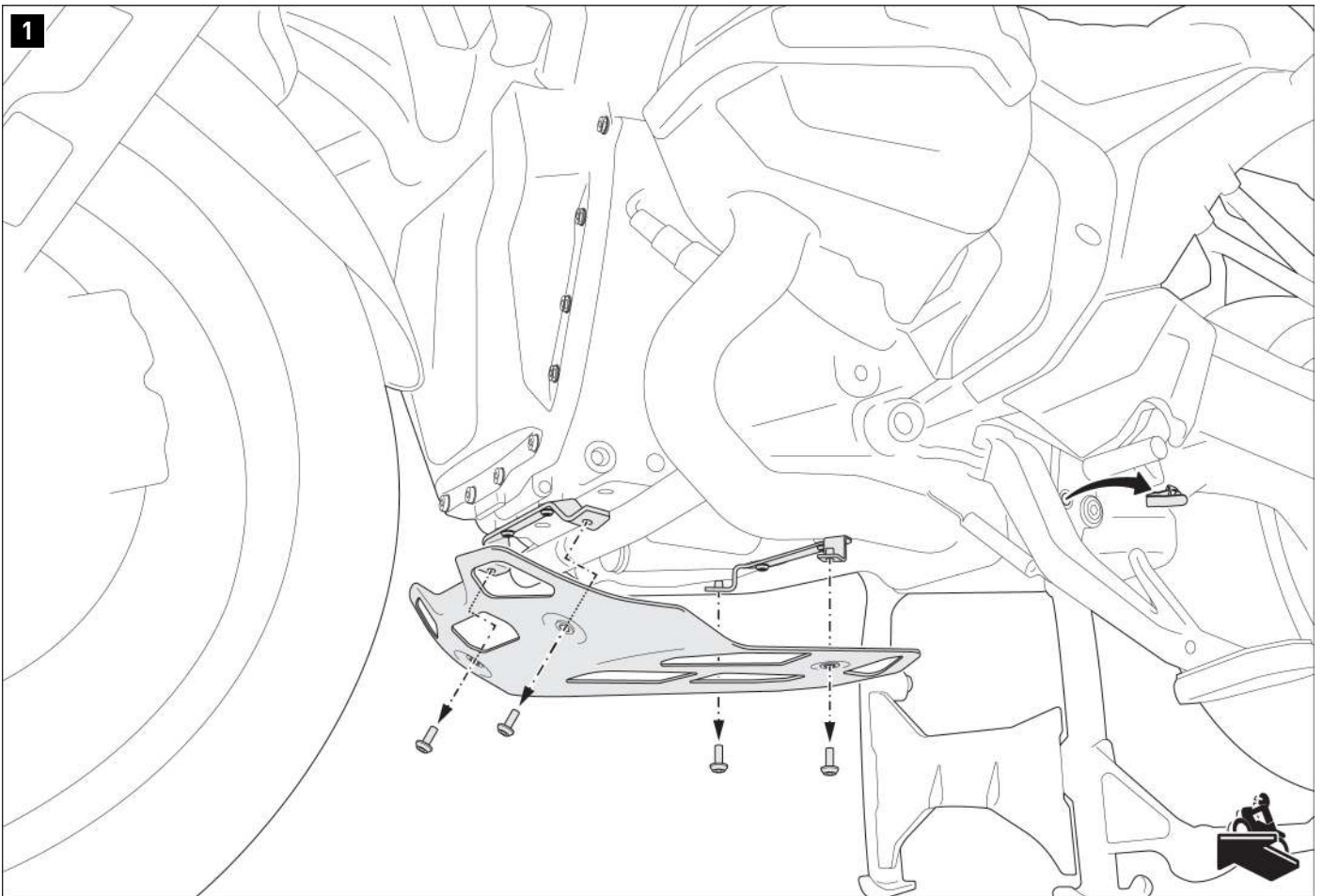

- ▲ **WARNING: Always wear eye and hand protection!**
- ▲ **WARNING: Always use the proper tools!**

Remove the original engine guard from the vehicle.



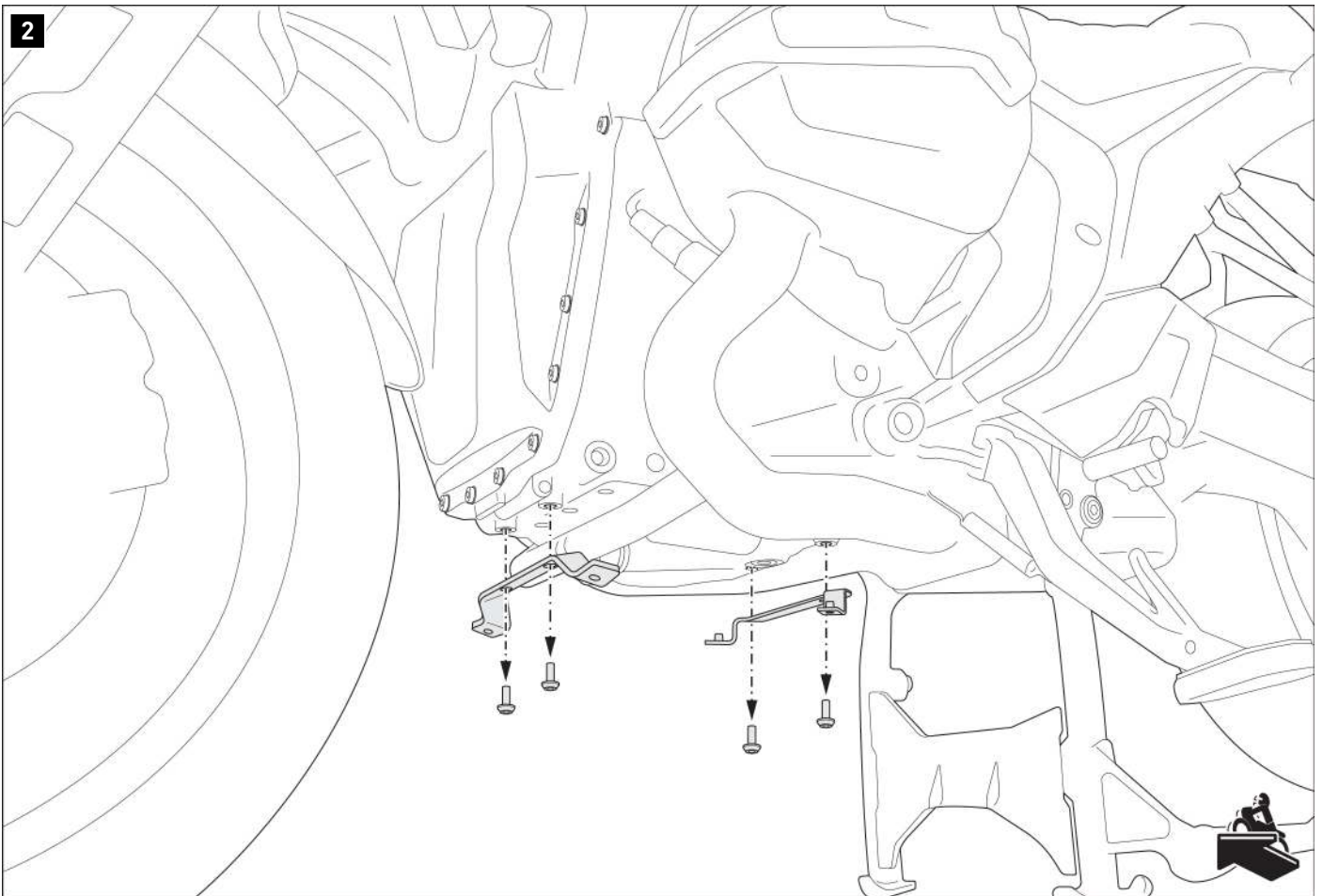

Remove the original retaining plates from the vehicle.

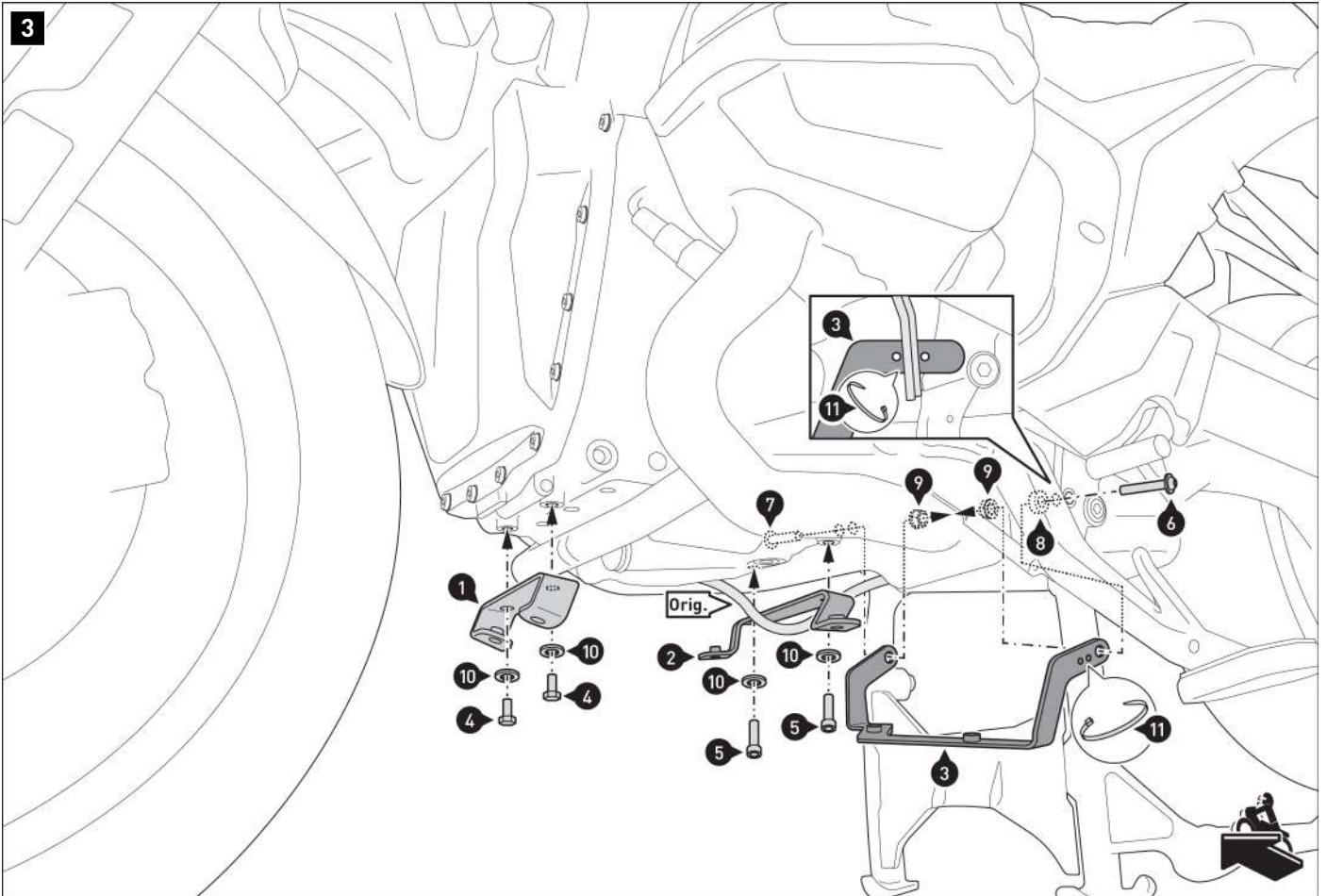

Screw the front (1), middle (2) and (3) rear mounting brackets to the vehicle.
▲ WARNING: Use liquid thread locker (only for screws (4) and (5))!
 Tighten the screws (4) and (5) according to the vehicle manufacturer's specifications.
 Tighten the screws (6) and (7) as specified in the mounting instructions.

Fasten the hoses to the rear mounting bracket (3) using the cable tie (11).

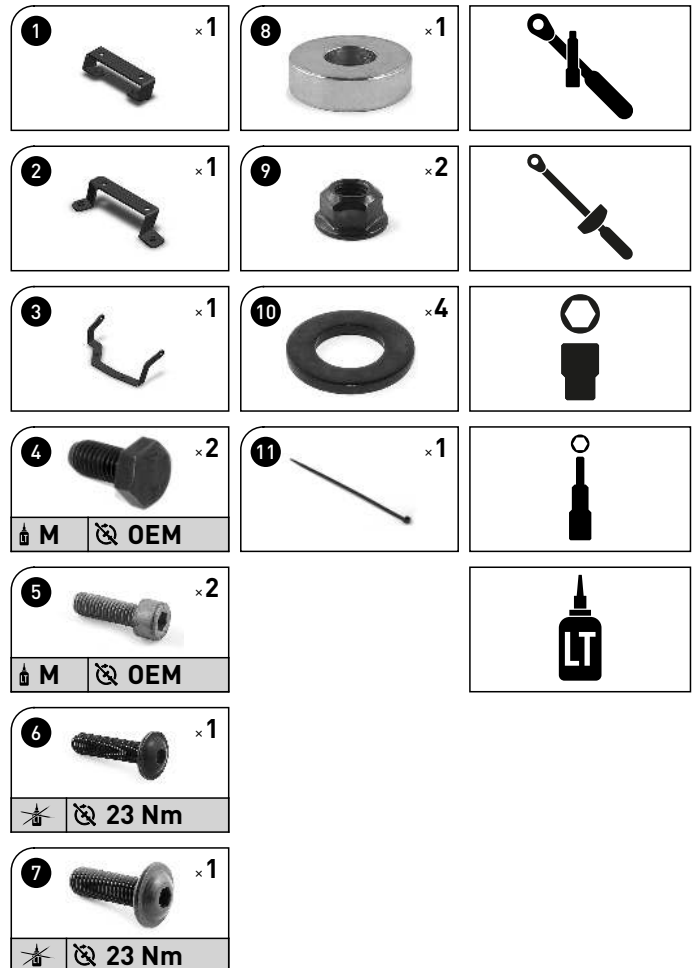

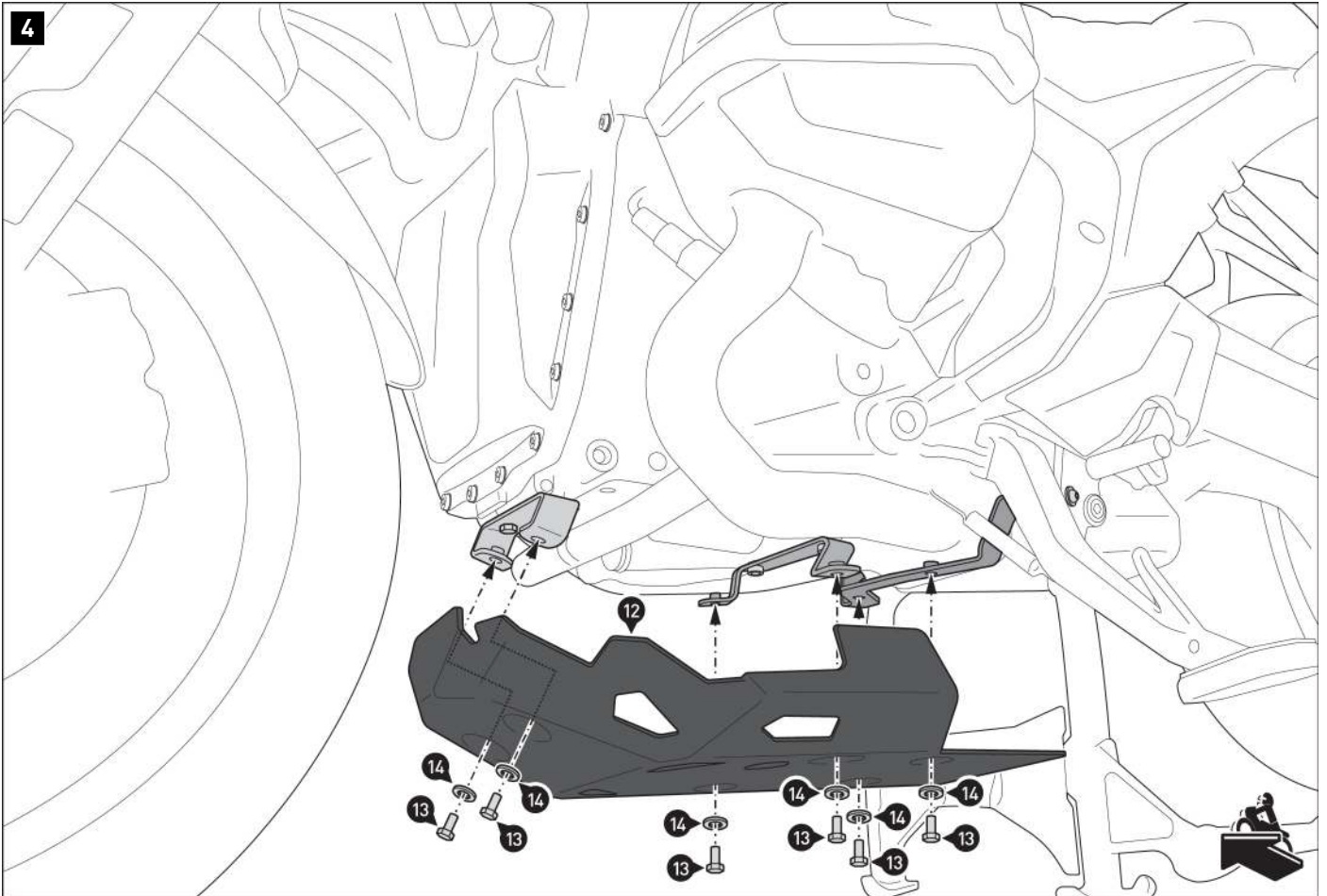

Screw the engine guard (12) onto the mounting brackets (1), (2) and (3).
▲ WARNING: Use a liquid threadlocker!
 Tighten the screws (13) as specified in the mounting instructions.

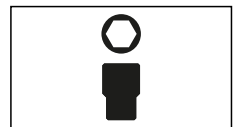
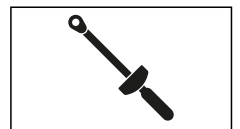

PRODUCT-SPECIFIC NOTES

⚠ WARNING: Ground clearance may be restricted by this product! Particular caution is required when cornering at extreme inclination and/or driving on uneven ground (e.g. curbs and bumps)!

⚠ WARNING: Motorcycle exhaust pipes often have large geometric tolerances. Make sure that there is sufficient distance between all parts in the affected areas!

⚠ NOTE: *Please observe the country-specific regulations for the registration/operation of your vehicle or any applicable TÜV regulations. After installation, parts subject to registration should be entered in the vehicle documents by your test center.*

Item number: **MSS.07.975.10200/B**Revision: **00** · Date: **01 - 2024**

Engine guard extension

 ~ 0.75 h.

 EASY      DIFFICULT

ENGLISH Thank you for choosing this premium product from SW-MOTECH. Visit our online shop for more information (e.g. model assignments). Required documents (e.g. national type approval) are available there for you to download.

Please read and understand all the instructions, safety information and warnings in these mounting instructions before mounting and using the product in order to avoid injury and damage. Keep these mounting instructions for reference.

This product was developed for vehicles in factory condition. Compatibility with original accessories or accessories from other manufacturers cannot be guaranteed.

These mounting instructions have been prepared to the best of our current knowledge. No legal claims relating to accuracy can be made. Errors and omissions excepted. We reserve the right to make technical and design changes. The copyright is held by SW-MOTECH.

SAFETY WARNING SYMBOL

 This warning symbol is used in these mounting instructions to warn of deadly dangers, injuries or other hazards. The words **DANGER**, **WARNING** or **CAUTION** are used as part of this warning symbol to convey important safety messages and information relating to the installation and use of this product. These words, together with the safety warning symbol, mean:

 **DANGER:** Indicates a hazardous situation which, if not avoided, will result in death or serious injury!

 **WARNING:** Indicates a hazardous situation which, if not avoided, may result in death or serious injury!

 **CAUTION:** Indicates a hazardous situation which, if not avoided, may result in minor or moderate injury!

 **NOTE:** Important information, but not relating to a risk of death or injury (property damage only)!

GENERAL INFORMATION

 **WARNING:** Assembly and/or maintenance of this product requires advanced technical skill, appropriate tools, and a good understanding of tool usage and torque specifications. For your own safety, SW-MOTECH recommends having the assembly and/or maintenance carried out by a qualified and certified motorcycle workshop.

 **WARNING:** If you do choose to assemble this product yourself, carefully and fully read the mounting instructions before assembly and use, and follow all instructions to avoid serious injury or death. Also observe all relevant information in the vehicle manual when mounting or using the product. IF YOU DO NOT UNDERSTAND ANY PART OF THESE MOUNTING INSTRUCTIONS OR NEED AN EXPLANATION AS TO A SPECIFIC INSTRUCTION, DO NOT ATTEMPT TO INSTALL THIS PRODUCT WITHOUT CONSULTING SW-MOTECH FOR ASSISTANCE!

PREPARATION: Read the mounting instructions carefully and make sure that all parts on the parts list are available.

 **CAUTION:** Ensure that your vehicle is standing securely. Switch off the engine and remove the ignition key. Allow the engine/exhaust to cool down if necessary. Disconnect the battery when working on the electrical system. Only use proper tools and always wear safety goggles and gloves during assembly and maintenance. Have a second person help you with assembly and maintenance.

ASSEMBLY: All parts and connections removed from the vehicle must be reinstalled according to the vehicle manufacturer's specifications or replaced with parts and hardware supplied by SW-MOTECH.

 **WARNING:** Secure all threads with a medium-strength liquid threadlocker, unless otherwise specified.

 **DANGER:** Tightening torques not defined by SW-MOTECH must be obtained from the vehicle manufacturer or a certified motorbike workshop.



FUNCTIONAL CHECK: After mounting the product, ensure that no moving parts are obstructed and that the function of the vehicle is not impeded. Cables and hoses must not rub against each other and/or be hindered in any way.

 **WARNING:** Carry out a comprehensive functionality check before you start to drive. Check the tightening torque of all connections and the tight fit of the product after the first 50 km and then at regular intervals. Mounted accessories can change the handling and stability of the vehicle.



SW-MOTECH GmbH & Co. KG
Ernteweg 7-10
35282 Rauschenberg
Germany



 info@sw-motech.com
 www.sw-motech.com



Take note of the symbols and what they mean in the ASSEMBLY section. If the term OEM appears in the ASSEMBLY section, the vehicle manufacturer's specifications must be observed and applied.



If you have any questions, please don't hesitate to contact our Customer Service team or our distributors. You can find our telephone number and a list of our distributors in our online shop:

www.sw-motech.com



Use thread locker: Indicates that a thread must be coated with liquid thread locker. H (HIGH): high strength; M (MEDIUM): medium strength; L (LOW): low strength.



Tighten/note the tightening torque information:

Indicates the tightening torque of a part specified by SW-MOTECH or the vehicle manufacturer (OEM).

PARTS LIST - READ AND KEEP MOUNTING INSTRUCTIONS!

3

1



MSS.07.975.005.11

 **1/1**

2



M6 x 55; ISO 7380
SC.ST.06.055.02.7380.109

 **2/2**

3



Ø 15 / ø 6,4 / h 28
DB.ST.150.064.028.01

 **2/2**

4



M6 x 40; ISO 7380
SC.ST.06.040.02.7380.109

 **2/2**

5



Ø 18 / ø 6,4 / h 10
DB.ST.0180.0064.0100.02

 **2/2**

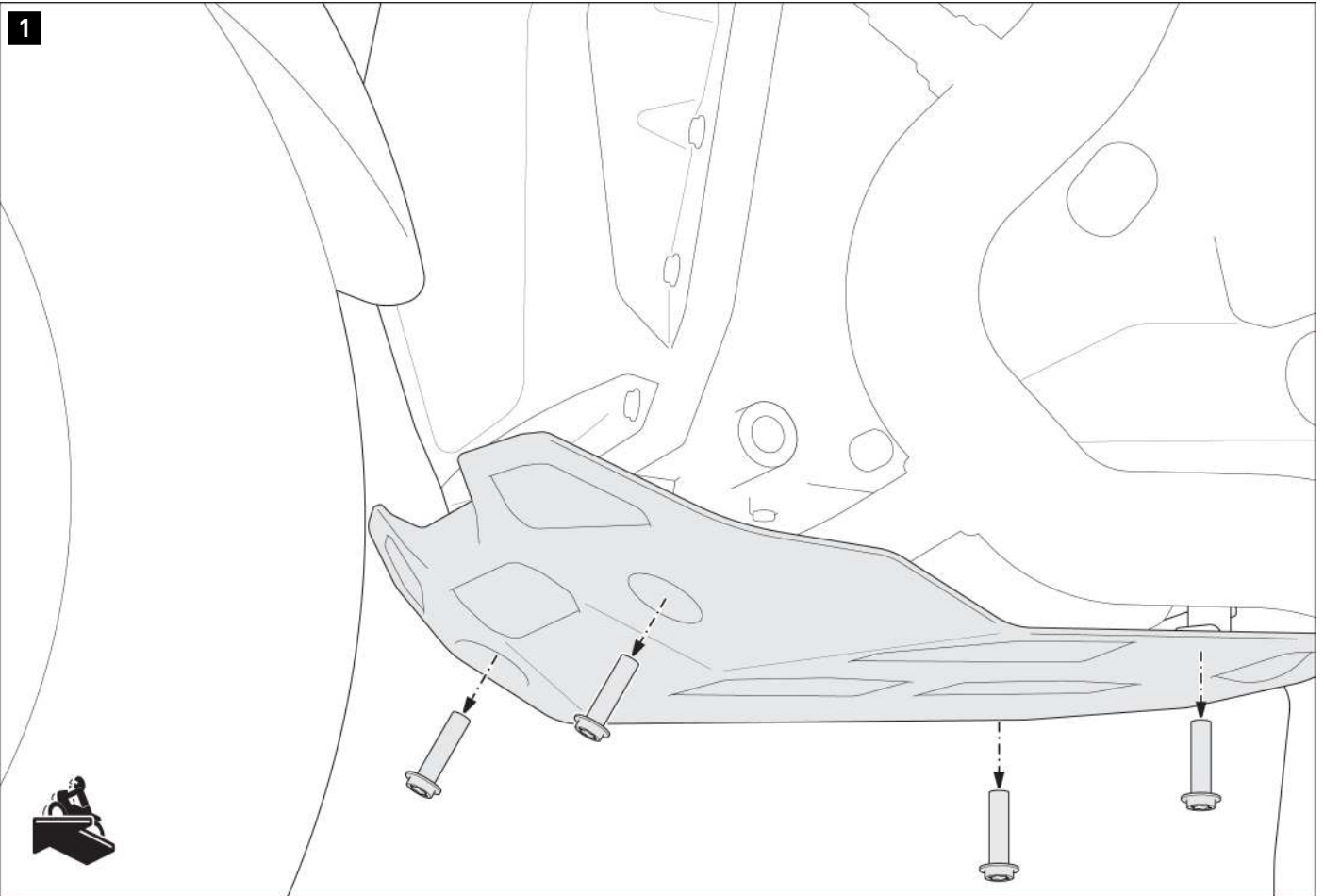

- ⚠ **WARNING: Always wear eye and hand protection!**
- ⚠ **WARNING: Always use the proper tools!**

⚠ **NOTE:** If the engine guard extension is to be mounted with the SW-MOTECH engine guard, the engine guard extension must be mounted first followed by the engine guard.

Loosen the four screws of the original engine guard.
Remove the engine guard from the vehicle.

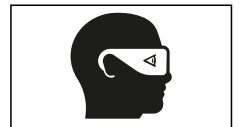

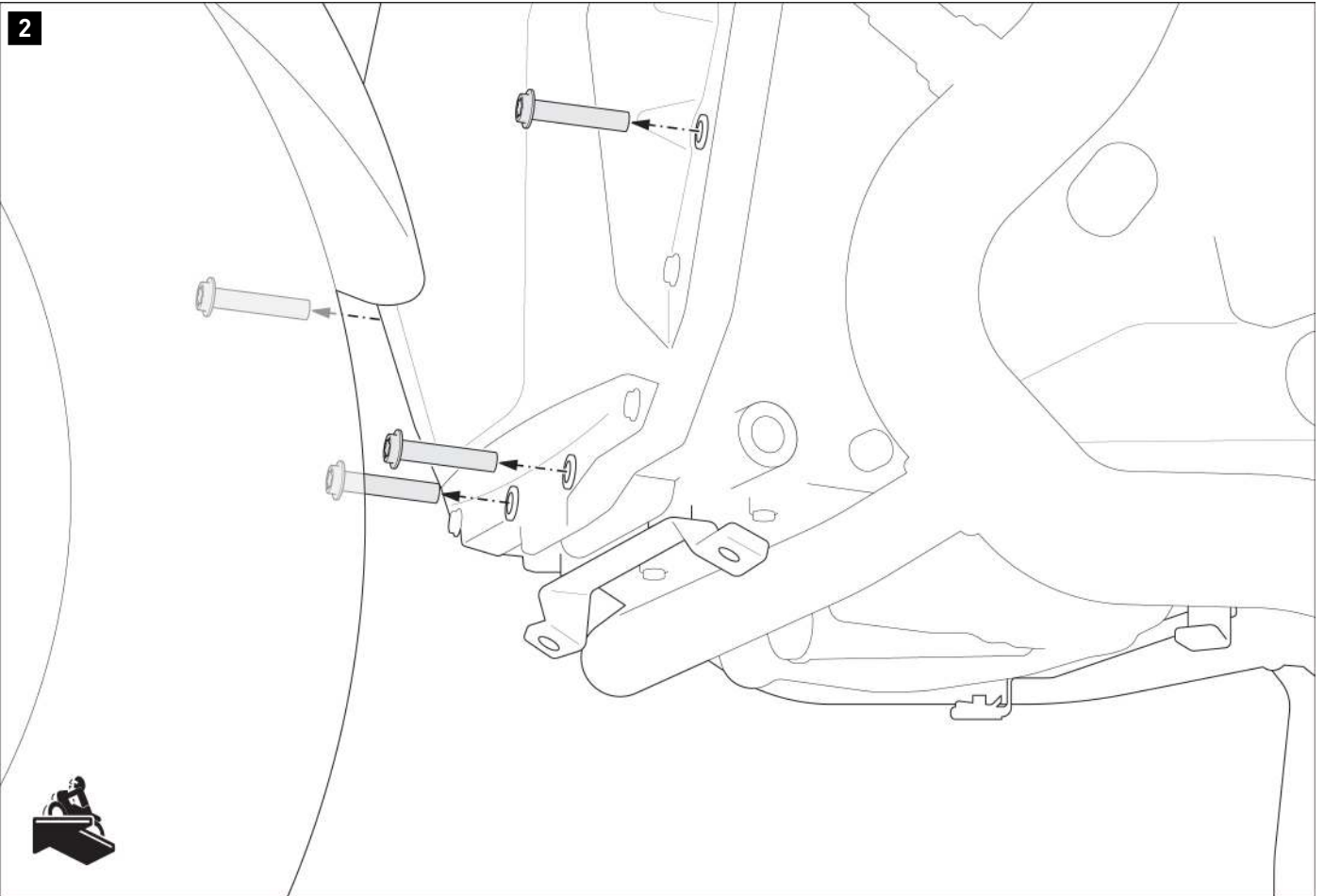

Remove the four original screws shown from the vehicle.

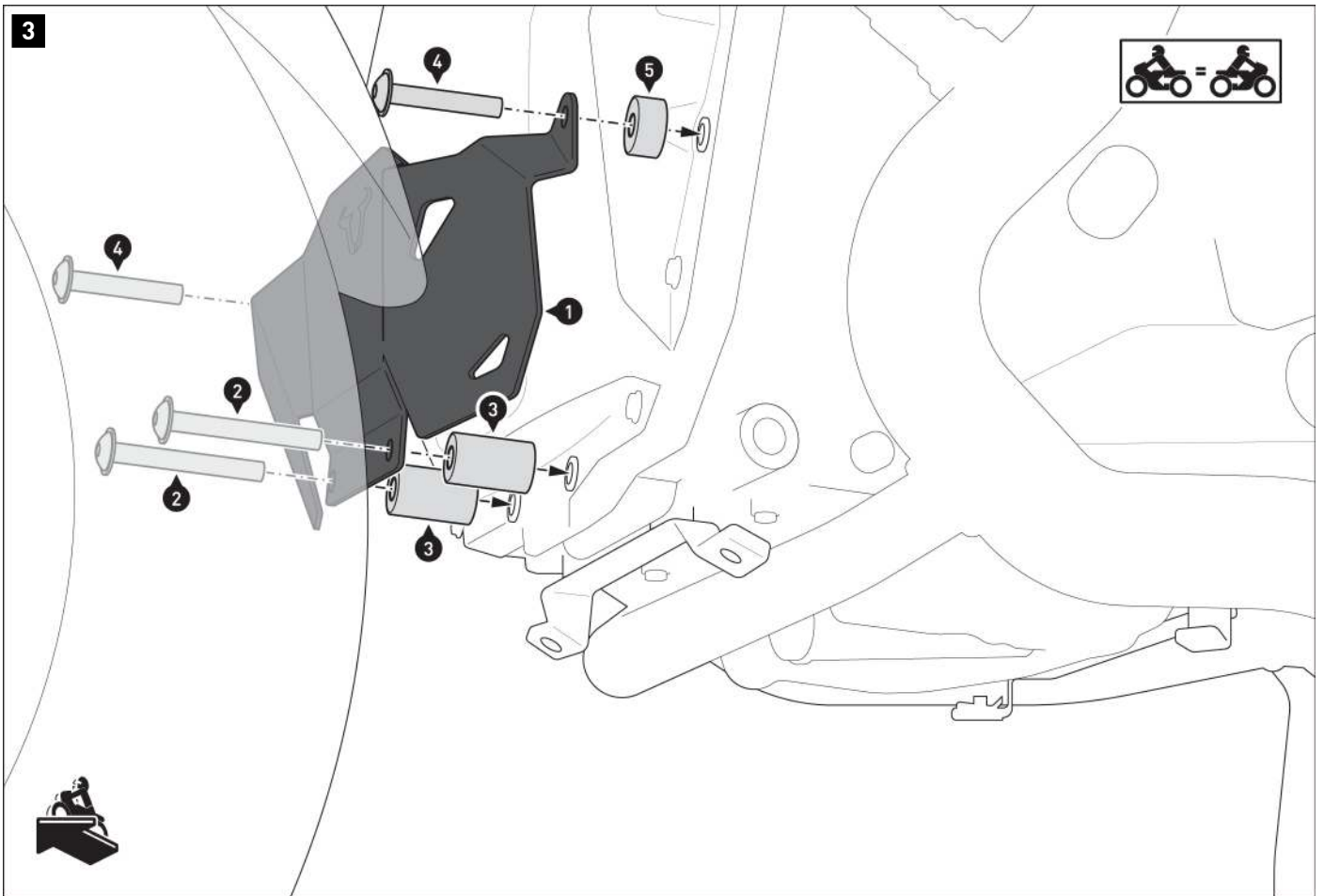

Screw the engine guard extension (1) onto the vehicle.

▲ WARNING: Use a liquid threadlocker!

Tighten the screws (2) and (4) according to the manufacturer's instructions.

Reinstall the original engine guard on the vehicle.

▲ WARNING: Use a liquid threadlocker!

Tighten the original screws according to the manufacturer's instructions.

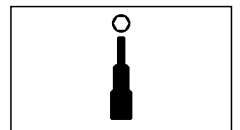
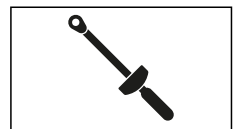

PRODUCT-SPECIFIC NOTES

⚠ WARNING: Ground clearance may be restricted by this product! Particular caution is required when cornering at extreme inclination and/or driving on uneven ground (e.g. curbs and bumps)!

⚠ WARNING: Motorcycle exhaust pipes often have large geometric tolerances. Make sure that there is sufficient distance between all parts in the affected areas!

⚠ NOTE: *Please observe the country-specific regulations for the registration/operation of your vehicle or any applicable TÜV regulations. After installation, parts subject to registration should be entered in the vehicle documents by your test center.*

Item number: **STP.07.176.10002/B**

Revision: **00** · Date: **09 - 2023**

Rear axle crash pad kit

 ~ 0.25 h.

EASY  DIFFICULT

ENGLISH Thank you for choosing this premium product from SW-MOTECH. Visit our online shop for more information (e.g. model assignments). Required documents (e.g. national type approval) are available there for you to download.

Please read and understand all the instructions, safety information and warnings in these mounting instructions before mounting and using the product in order to avoid injury and damage. Keep these mounting instructions for reference.

This product was developed for vehicles in factory condition. Compatibility with original accessories or accessories from other manufacturers cannot be guaranteed.

These mounting instructions have been prepared to the best of our current knowledge. No legal claims relating to accuracy can be made. Errors and omissions excepted. We reserve the right to make technical and design changes. The copyright is held by SW-MOTECH.

SAFETY WARNING SYMBOL

 This warning symbol is used in these mounting instructions to warn of deadly dangers, injuries or other hazards. The words **DANGER**, **WARNING** or **CAUTION** are used as part of this warning symbol to convey important safety messages and information relating to the installation and use of this product. These words, together with the safety warning symbol, mean:

 **DANGER:** Indicates a hazardous situation which, if not avoided, will result in death or serious injury!

 **WARNING:** Indicates a hazardous situation which, if not avoided, may result in death or serious injury!

 **CAUTION:** Indicates a hazardous situation which, if not avoided, may result in minor or moderate injury!

 **NOTE:** Important information, but not relating to a risk of death or injury (property damage only)!

GENERAL INFORMATION

 **WARNING:** Assembly and/or maintenance of this product requires advanced technical skill, appropriate tools, and a good understanding of tool usage and torque specifications. For your own safety, SW-MOTECH recommends having the assembly and/or maintenance carried out by a qualified and certified motorcycle workshop.

 **WARNING:** If you do choose to assemble this product yourself, carefully and fully read the mounting instructions before assembly and use, and follow all instructions to avoid serious injury or death. Also observe all relevant information in the vehicle manual when mounting or using the product. IF YOU DO NOT UNDERSTAND ANY PART OF THESE MOUNTING INSTRUCTIONS OR NEED AN EXPLANATION AS TO A SPECIFIC INSTRUCTION, DO NOT ATTEMPT TO INSTALL THIS PRODUCT WITHOUT CONSULTING SW-MOTECH FOR ASSISTANCE!

PREPARATION: Read the mounting instructions carefully and make sure that all parts on the parts list are available.

 **CAUTION:** Ensure that your vehicle is standing securely. Switch off the engine and remove the ignition key. Allow the engine/exhaust to cool down if necessary. Disconnect the battery when working on the electrical system. Only use proper tools and always wear safety goggles and gloves during assembly and maintenance. Have a second person help you with assembly and maintenance.

ASSEMBLY: All parts and connections removed from the vehicle must be reinstalled according to the vehicle manufacturer's specifications or replaced with parts and hardware supplied by SW-MOTECH.

 **WARNING:** Secure all threads with a medium-strength liquid threadlocker, unless otherwise specified.

 **DANGER:** Tightening torques not defined by SW-MOTECH must be obtained from the vehicle manufacturer or a certified motorbike workshop.



FUNCTIONAL CHECK: After mounting the product, ensure that no moving parts are obstructed and that the function of the vehicle is not impeded. Cables and hoses must not rub against each other and/or be hindered in any way.

 **WARNING:** Carry out a comprehensive functionality check before you start to drive. Check the tightening torque of all connections and the tight fit of the product after the first 50 km and then at regular intervals. Mounted accessories can change the handling and stability of the vehicle.



SW-MOTECH GmbH & Co. KG
Ernteweg 7-10
35282 Rauschenberg
Germany



 info@sw-motech.com
 www.sw-motech.com



Take note of the symbols and what they mean in the ASSEMBLY section. If the term OEM appears in the ASSEMBLY section, the vehicle manufacturer's specifications must be observed and applied.



If you have any questions, please don't hesitate to contact our Customer Service team or our distributors. You can find our telephone number and a list of our distributors in our online shop:

www.sw-motech.com











Use thread locker: Indicates that a thread must be coated with liquid thread locker. H (HIGH): high strength; M (MEDIUM): medium strength; L (LOW): low strength.



Tighten/note the tightening torque information:

Indicates the tightening torque of a part specified by SW-MOTECH or the vehicle manufacturer (OEM).

PARTS LIST - READ AND KEEP MOUNTING INSTRUCTIONS!

2	1 	2 	3 	4 	5 	6 
	STP.00.176.004/B 1/1	M8 x 50; DIN 912 SC.ST.08.050.48.912.109 1/1	ø 8,4; DIN 9021 US.ST.084.02.9021 1/1	Ø 19 / ø 8,5 / h 4,4 DB.AL.0190.0085.0044.02 1/1	STP.00.176.009.35 1/1	CPA.00.424.016 1/1
3	7 	8 				
	STP.00.176.006.01 1/1	STP.00.176.005/B 1/1				

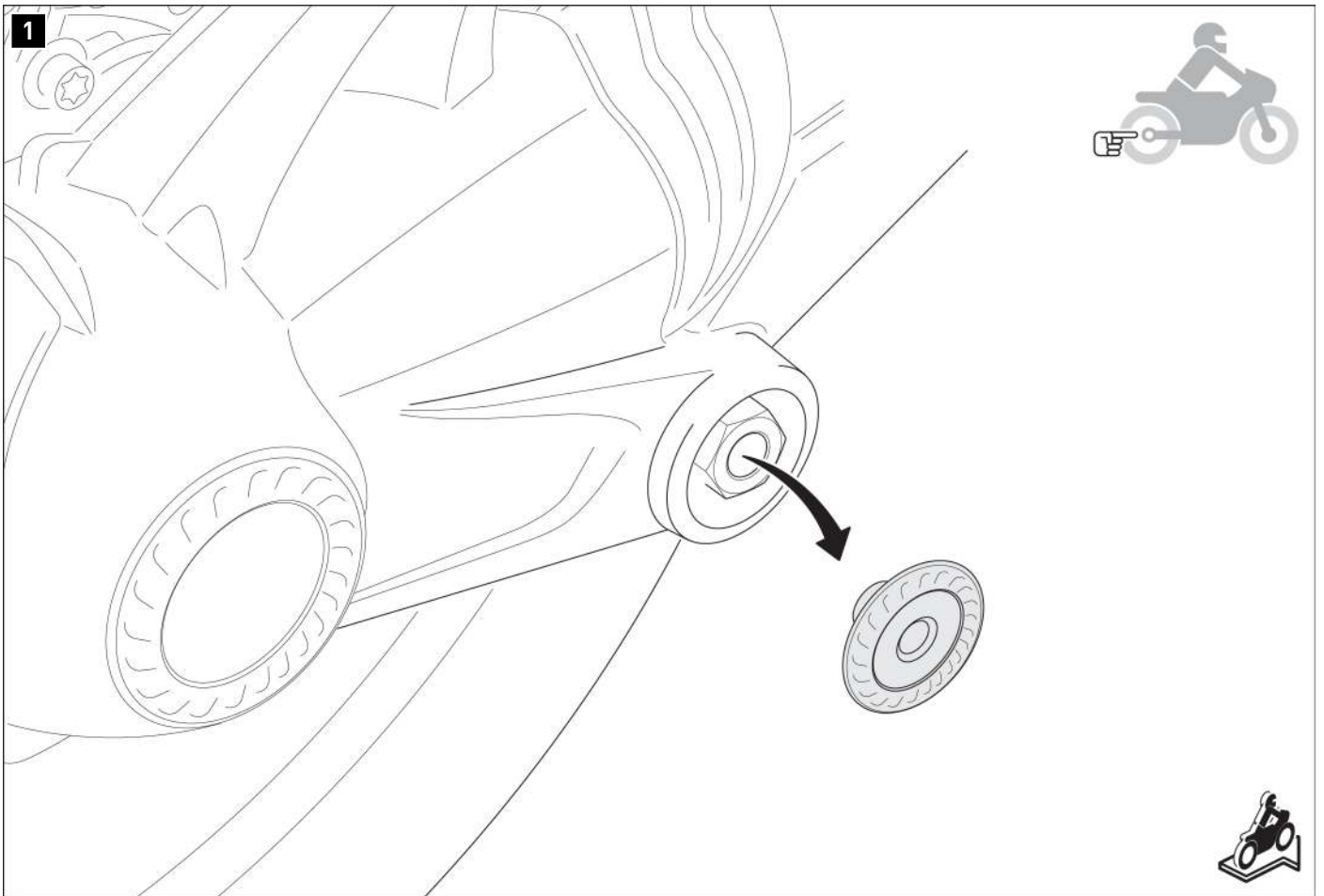

- ▲ **WARNING: Always wear hand and eye protection!**
- ▲ **WARNING: Always use the proper tools!**

Remove the original cover cap from the attachment point on the swing arm.

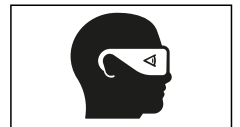

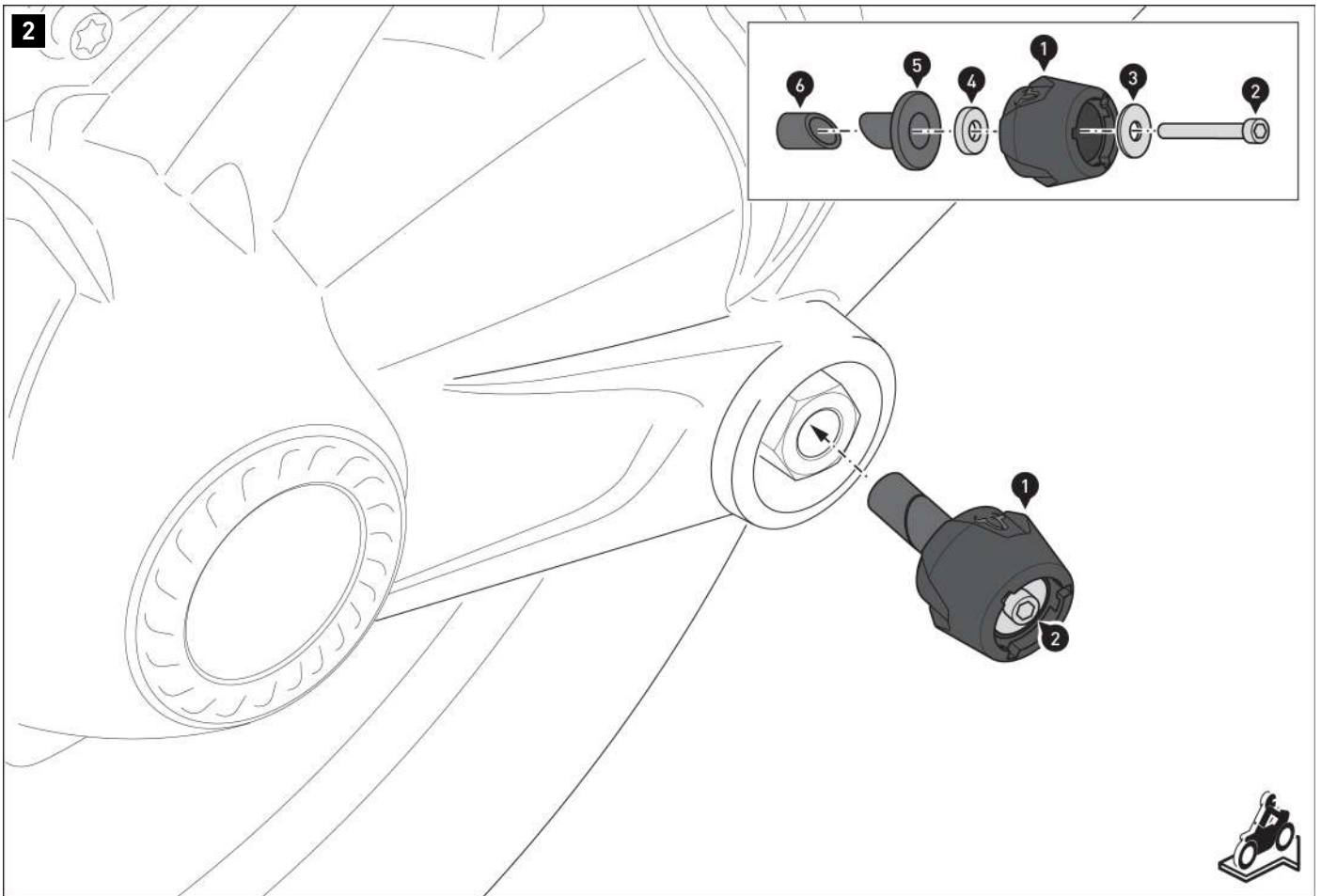

Loosely screw parts (1) to (6) together as shown in the detailed drawing.

▲ WARNING: Use low-strength liquid thread locker!

Mount the crash pad (1) on to the swing arm using the parts indicated. Tighten the screw (2) so that collets (5) and (6) wedge into the attachment point.

⚠ NOTE: Tighten the screw (2) to a maximum of 9 Nm to avoid damaging the components!

Make sure the crash pad (1) is securely positioned on the swing arm.

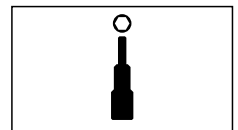
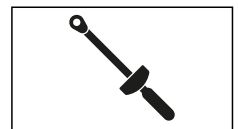

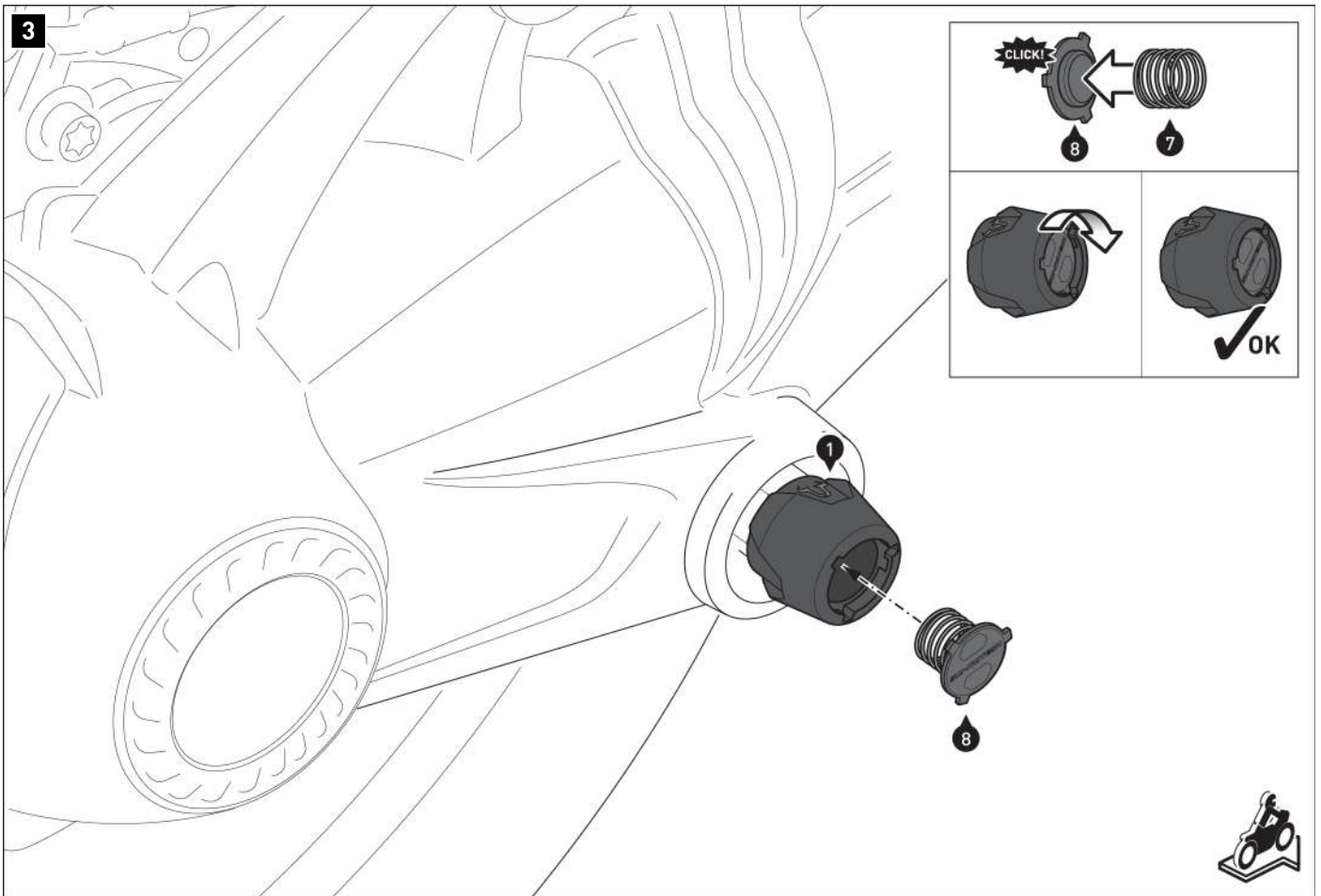

Insert the spring (7) into the cover cap (8) as shown in the detailed drawing.

Insert the cover cap (8) into the opening of the mounted crash pad (1) and turn it to the end position.

⚠ NOTE: Make sure the cover cap (8) is securely positioned.



PRODUCT-SPECIFIC NOTES

⚠ NOTE: *Observe the country-specific regulations for the registration/operation of your vehicle or applicable TÜV regulations. After assembly, have parts that are subject to registration entered in the vehicle documents by your test centre.*

Art.-Nr. / Item No.: **STP.07.176.11001/B**

Revision: **01** · Datum / Date: **11 - 2021**

Sturzpad-Kit für Vorderachse

Slider set for front axle

DEUTSCH - Vielen Dank, dass Sie sich für dieses Premium-Produkt von SW-MOTECH entschieden haben. Bitte besuchen Sie unseren Webshop für weitere Informationen wie Modellzuweisungen und PDF-Anbauanleitung. Erforderliche Dokumente (z. B. ABE) stehen als Download zur Verfügung.

Die Montage und/oder Wartung dieses Produkts erfordert ein gutes technisches Verständnis! Zu Ihrer eigenen Sicherheit empfiehlt SW-MOTECH, die Montage und/oder Wartung durch eine Fachwerkstatt durchführen zu lassen! SW-MOTECH übernimmt keine Haftung für Schäden, die durch eine unsachgemäße Montage und/oder Wartung verursacht wurden!

Beachten Sie alle in der Anbauanleitung angegebenen Hinweise und die für die Montage relevanten Informationen im Fahrzeughandbuch. Nichtbeachtung kann zu Schäden am Fahrzeug bzw. zur Gefährdung des Fahrers führen! Diese Anbauanleitung ist nach unserem derzeitigen Kenntnisstand verfasst worden. Rechtliche Ansprüche auf Richtigkeit bestehen nicht.

Dieses Produkt wurde für Fahrzeuge im Werkzustand entwickelt. Die Kompatibilität mit Original-Zubehörteilen bzw. den Zubehörteilen anderer Hersteller kann nicht gewährleistet werden. Stellen Sie des Weiteren VOR Montage dieses Produkts sicher, dass sich alle beweglichen Teile (z. B. die Kette) im ursprünglichen Wartungszustand befinden. Montiertes Zubehör kann das Fahrverhalten und/oder die Stabilität Ihres Fahrzeugs verändern.

ALLGEMEINE HINWEISE

Beachten Sie die landesspezifischen Vorschriften für Zulassung/Betrieb Ihres Fahrzeugs bzw. anwendbare TÜV-Vorschriften. Lassen Sie eintragungspflichtige Teile nach Montage durch Ihre Prüfstelle in die Fahrzeugpapiere eintragen.

VORBEREITUNG: Lesen Sie die Anbauanleitung aufmerksam und stellen Sie sicher, dass alle Teile der Stückliste vorhanden sind. Achten Sie darauf, dass Ihr Fahrzeug sicher steht und nicht umfallen kann. Schalten Sie den Motor ab und ziehen Sie den Zündschlüssel. Lassen Sie ggf. den Motor/Auspuff abkühlen. Klemmen Sie bei Arbeiten an der Elektrik die Fahrzeugbatterie ab. Verwenden Sie geeignetes Werkzeug. Lassen Sie sich von einer zweiten Person helfen.

MONTAGE: Alle vom Motorrad gelösten Teile und Verbindungen sind gemäß den Fahrzeugherstellereangaben wieder zu montieren oder durch die von SW-MOTECH gelieferten Teile zu ersetzen. Sichern Sie, falls nicht anderweitig definiert, alle Gewinde mit mittelfester, flüssiger Schraubensicherung.

Alle nicht durch SW-MOTECH definierten Anzugsmoment-Vorgaben müssen beim Fahrzeughersteller oder einer Fachwerkstatt erfragt werden!

FUNKTIONSKONTROLLE: Stellen Sie nach der Montage sicher, dass alle zuvor gelösten Teile und Verbindungen wieder ordnungsgemäß montiert wurden. Achten Sie außerdem auf die uneingeschränkte Freigängigkeit und einwandfreie Funktion sämtlicher Fahrzeugteile. Kabel, Züge und Schläuche dürfen nicht scheuern und/oder geklemmt werden. Führen Sie vor Fahrtbeginn eine umfassende Funktionskontrolle durch. Überprüfen Sie nach den ersten 50 km und anschließend in regelmäßigen Abständen das Anzugsmoment aller Schraubverbindungen und den ordnungsgemäßen Sitz des Produkts.

ENGLISH - Thank you for choosing this premium product from SW-MOTECH. Please visit our webshop for additional information, such as application charts and PDF mounting instructions. Any other documents that may be required (e.g. ABE certifications), are also available for download at our webshop.

Installation and/or maintenance of this product require good technical understanding! For your own safety SW-MOTECH recommends having installation and/or servicing carried out by a specialist workshop! SW-MOTECH assumes no liability for damage caused by improper installation and/or maintenance work!

Carefully follow all the directions given in the mounting instructions and pay attention to all relevant information in the vehicle manual during assembly. Nonconformance can lead to vehicle damage or even endanger the driver! These mounting instructions are written based on our current state of knowledge. Legal requirements for accuracy do not exist.

This product was developed for vehicles in their factory setting. Compatibility with original accessory parts or other manufacturers' accessory parts is not guaranteed. Furthermore, BEFORE installing this product, make sure that all moving parts (e.g. the chain) are in the original state of maintenance. Installed accessories can change the driving behaviour and/or stability of your vehicle.

GENERAL INFORMATION

Observe the country-specific regulations concerning vehicle registration/operation as well as TÜV regulations if applicable. If required, register installed parts in the vehicle documents through an appropriate inspection authority.

PREPARATION: Read the mounting instructions carefully and make sure that all items of the parts list are included. Make sure that your vehicle is parked safely and cannot fall over. Turn off the engine and remove the ignition key. Let the motor/exhaust cool off if necessary. Disconnect the vehicle battery when working on the electrical system. Use appropriate tools. Have another person to help you.

MOUNTING: All parts and connections removed from the vehicle must be reinstalled in accordance with the vehicle manufacturers' specifications or replaced by parts delivered by SW-MOTECH. Secure all threads, unless otherwise specified, with medium-strength liquid thread locker.

Torque specifications undefined by SW-MOTECH must be obtained from the vehicle manufacturer or by a specialist workshop!

FUNCTION CHECK: After installation make sure that all parts and connections previously removed are properly replaced. Also make sure that no moving parts are obstructed and no function of the vehicle is hindered in any way. Cables and hoses must not rub and/or be pinched. Before starting to ride, perform a comprehensive check of all functions. After the first 50 km and then at regular intervals, check the tightening torque of all screw connections and the proper fit of the product.

Konfektionierung durch / Packed by:

Datum der Konfektionierung / Date of packaging:



SW-MOTECH GmbH & Co. KG
Ernteweg 7-10
35282 Rauschenberg
Germany

Tel. / phone + 49 (0)6425 / 8168 - 050
Fax / fax + 49 (0)6425 / 8168 - 10
info@sw-motech.com
www.sw-motech.com

STÜCKLISTE / PARTS LIST

Schritt Step	Nr. No.	Art.-Nr. / Bezeichnung ^a Item No. / Description ^a	Artikel	Part	Anzahl ^b Quantity ^b	N·m ^c
1	(1)	GST.ST.08.315	Gewindestange; Länge 315 mm	Threaded Rod; length 315 mm	1 / 1	
	(2)	STP.00.176.014	Buchse; links; Höhe 8 mm	Spacer; left; height 8 mm	1 / 1	
	(3)	STP.00.176.025	Buchse, gestuft; rechts; Höhe 24 mm	Spacer, stepped; right; height 24 mm	1 / 1	
	(4)	M8; DIN 439	Mutter, niedrige Form	Nut, low form	2 / 2	18
2	(5)	STP.00.176.004	Sturzpad	Slider	2 / 2	
	(6)	∅ 19 / ∅ 15,2 / h 4,4	Auflagebuchse; schwarz	Support Spacer; black	2 / 2	
	(7)	∅ 8,4; DIN 9021	Unterlegscheibe; schwarz	Washer; black	2 / 2	
	(8)	M8; DIN 985	Mutter, selbstsichernd	Lock Nut	2 / 2	18
3	(9)	STP.00.176.005 / ...006	Abdeckkappe mit Feder	Cover Cap with Spring	2 / 2	

8.8	Regelgewinde / Coarse Thread ∅							10.9	Regelgewinde / Coarse Thread ∅						
	M4	M5	M6	M8	M10	M12	M4		M5	M6	M8	M10	M12		
	Stahl FK 8.8 / Steel CL 8.8								Stahl FK 10.9 / Steel CL 10.9						
	N·m								N·m						
	2,8	5,5	9,6	23	46	79		4,1	8,1	14	34	67	115		

Anmerkungen: ^a Alle Maßangaben in Millimeter. ^b Der zweite Wert gibt die Gesamtanzahl des jew. Artikels in der Lieferung an. ^c **Keine Anzugsmomentvorgabe: Verwenden Sie das vom Fzg.-Hersteller definierte Anzugsmoment!** Das Std.-Anzugsmoment der Tabelle kann verwendet werden, wenn es den Fzg.-Hersteller-Vorgaben entspricht.

Note: ^a All measurements in millimeters. ^b The second number indicates the total quantity of the part in the delivery. ^c **No torque specifications: Use the torque defined by vehicle manufacturer!** The standard torque in this table can be used as long as it is within the vehicle manufacturer's specifications.

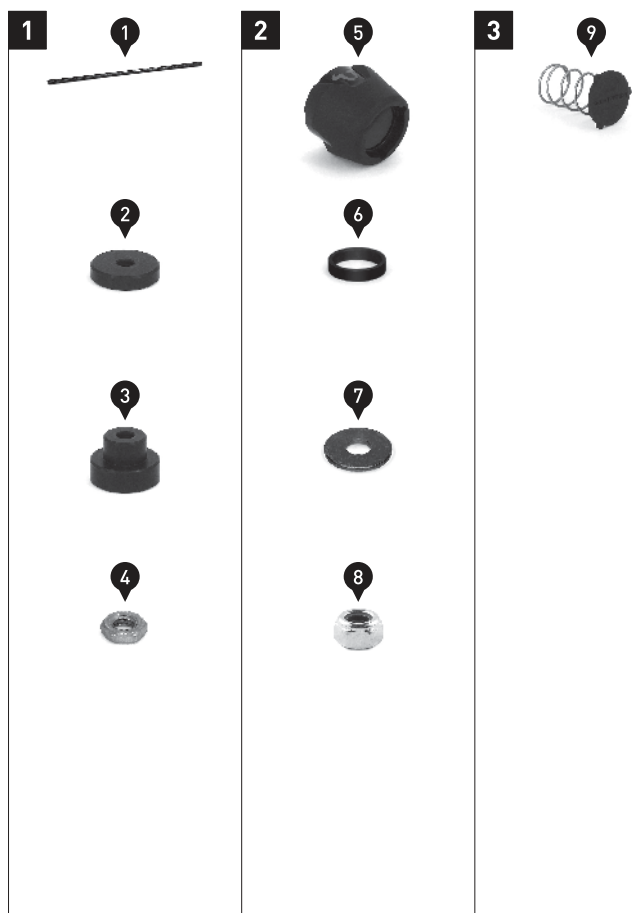

MONTAGE / MOUNTING

1

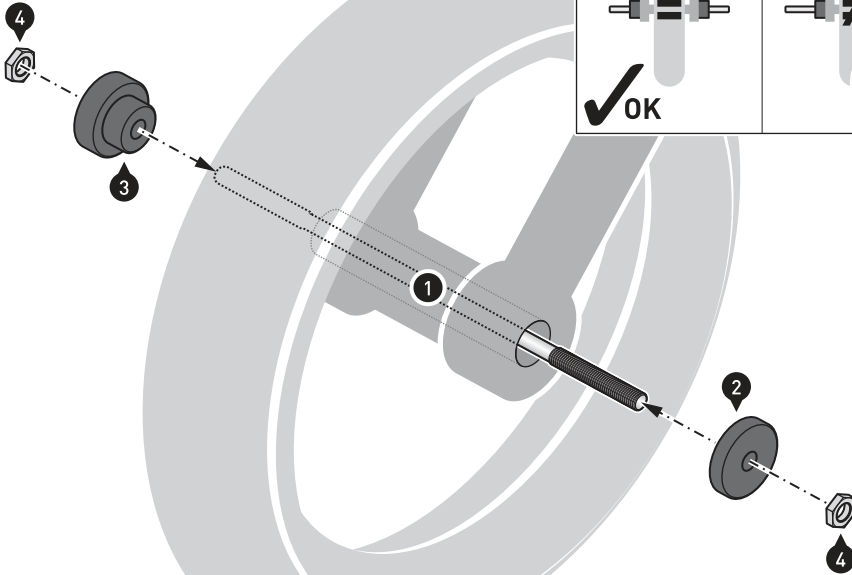

Führen Sie die Gewindestange (1) durch die **vordere** Achsaufnahme Ihres Fahrzeugs.

Stecken Sie nun die Buchsen (2) und (3) auf die Gewindestange (1) auf, wie in der Zeichnung gezeigt.

ACHTUNG: Achten Sie auf die zentrierte Ausrichtung der Gewindestange (1)!

Montieren Sie anschließend die gezeigten Komponenten mit den Muttern (4) am Fahrzeug.

ACHTUNG: Verwenden Sie flüssige Schraubensicherung!

Ziehen Sie die Muttern (4) wie vorgegeben an.

Guide the threaded rod (1) through the **front** axle mount of your vehicle.

Then plug the spacers (2) and (3) onto the threaded rod (1), as shown in the drawing.

ATTENTION: Pay attention to the centered alignment of the threaded rod (1)!

Then mount the shown components with the nuts (4) to the vehicle.

ATTENTION: Use liquid thread locker!

Tighten the nuts (4) as specified.



18 N·m



Medium



Das Fahrzeug dient als Beispiel. / Example vehicle shown.

2

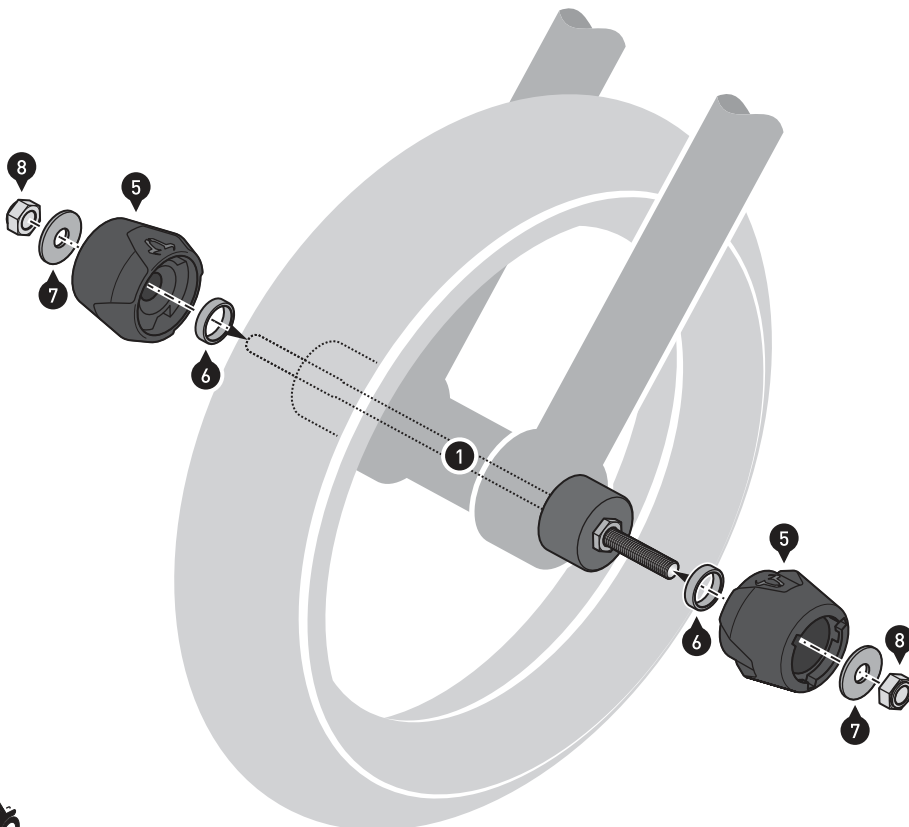

Montieren Sie die Sturz pads (5) mit den Muttern (8) **beidseitig** an der Gewindestange (1).

Ziehen Sie die Muttern (8) wie vorgegeben an.

Mount the sliders (5) with the nuts (8) on **both sides** to the threaded rod (1).

Tighten the nuts (8) as specified.



18 N·m



Das Fahrzeug und die montierten Buchsen dienen als Beispiele. / The vehicle and the mounted spacers are examples.

3

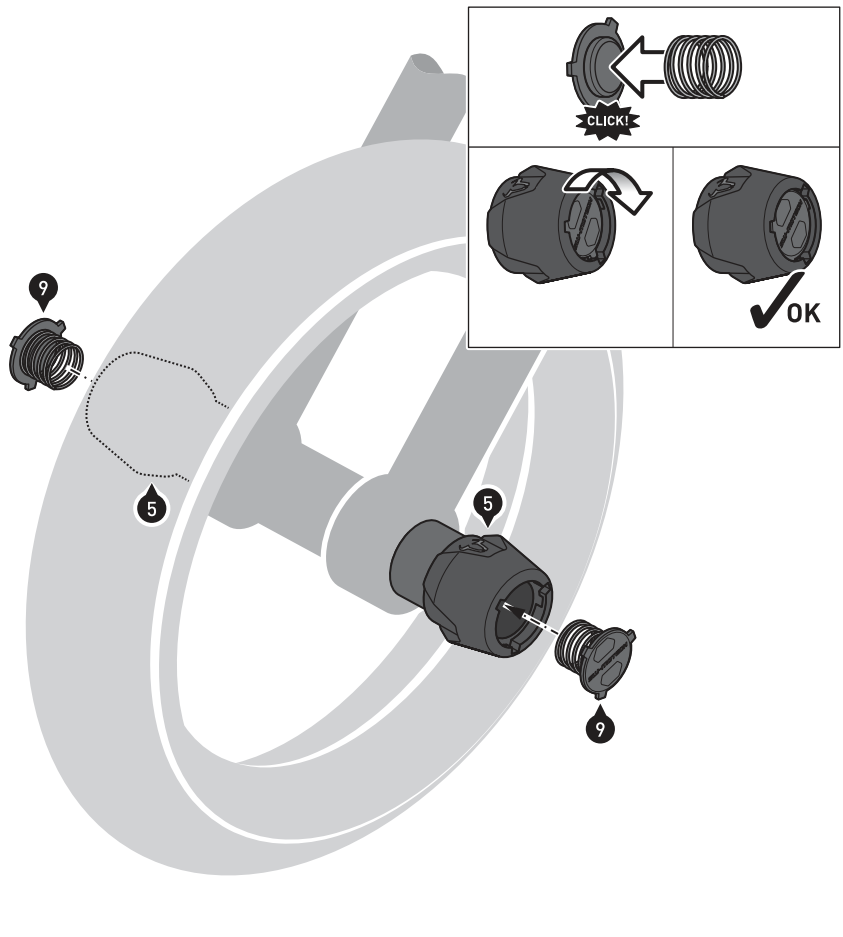

Setzen Sie **beidseitig** die Abdeckkappen (9) in die Öffnungen der montierten Sturz pads (5) ein und drehen Sie diese bis in die Endposition.

ACHTUNG: Achten Sie auf den festen Sitz der Abdeckkappen (9).

Insert the cover caps (9) on **both sides** into the openings of the mounted sliders (5) and turn them to their end position.

ATTENTION: Make sure that the cover caps (9) fit firmly.



Das Fahrzeug und die montierten Buchsen dienen als Beispiele. / The vehicle and the mounted spacers are examples.